

Specifications

- Current rating: 10A AC, DC
- Voltage rating: 300V AC, DC
- Temperature range: -25°C ~ +85°C
- Contact resistance: 7mΩ Max.
- Insulation resistance: 1000MΩ Min.
- Withstanding voltage: 1500V AC/minute
- *Compliant with RoHS and REACH*
- *Meet the HF/Halogen Free, GWT/Glow wire Test (IEC60335-1) request, need to customize*
- *Contact HDGC for details*

Assembly layout

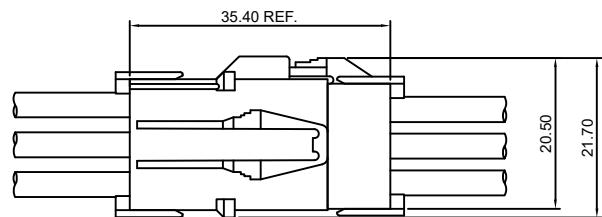

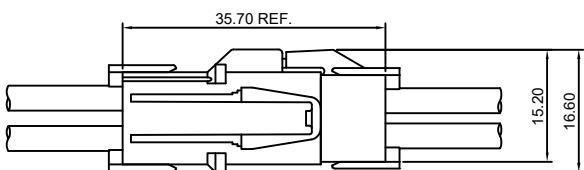
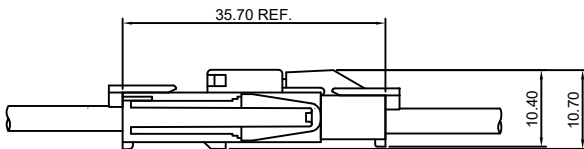
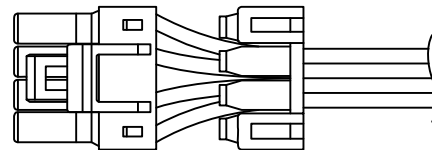
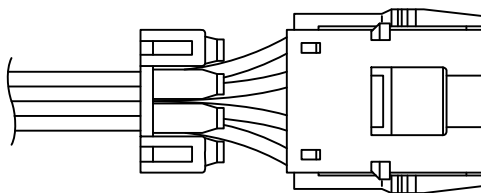

Panel hole layout

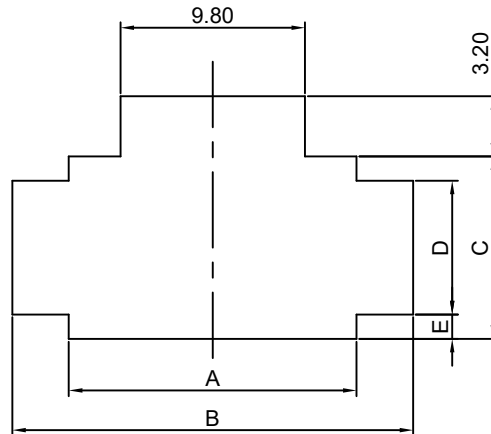

Unit:mm

PART NO.	Panel thickness and Dimensions (mm)								
	0.70 to 2.00			0.70 to 0.80		0.90 to 1.30		1.40 to 2.00	
	A	B	C	D	E	D	E	D	E
HDGC4501HM-2P	10.70	16.80	7.10	4.40	1.35	5.00	1.05	5.60	0.75
HDGC4501HM-3P	15.30	21.30	7.10	4.40	1.35	5.00	1.05	5.60	0.75
HDGC4501HM-2x2P	10.70	16.80	12.90	7.10	2.90	7.70	2.60	8.30	2.30
HDGC4501HM-2x3P	15.30	21.30	12.90	7.10	2.90	7.70	2.60	8.30	2.30
HDGC4501HM-2x4P	19.80	25.80	12.90	7.10	2.90	7.70	2.60	8.30	2.30
HDGC4501HM-2x6P	28.90	34.80	12.90	7.10	2.90	7.70	2.60	8.30	2.30
HDGC4501HM-2x8P	37.90	43.80	12.90	7.10	2.90	7.70	2.60	8.30	2.30
HDGC4501HM-3x3P	15.30	21.30	18.20	7.10	5.55	7.70	5.25	8.30	4.95
HDGC4501HM-3x4P	19.80	25.80	18.20	7.10	5.55	7.70	5.25	8.30	4.95
HDGC4501HM-3x5P	24.40	30.30	18.20	7.10	5.55	7.70	5.25	8.30	4.95

- Note: 1. Punch holes in the panel according to the figures and table shown above. Burrs must be removed.
 2. The strength of the panel must be considered when punching two or more holes.
 3. The connector must be inserted from the same side as the hole is punched.



HDGC4501 Series 4.50mm (.177") Pitch Wire to Wire Connector

HDGC4501F-T

4.50mm pitch Crimp Terminal

Reference Informations:

*Used in HDGC4501HF series Housing

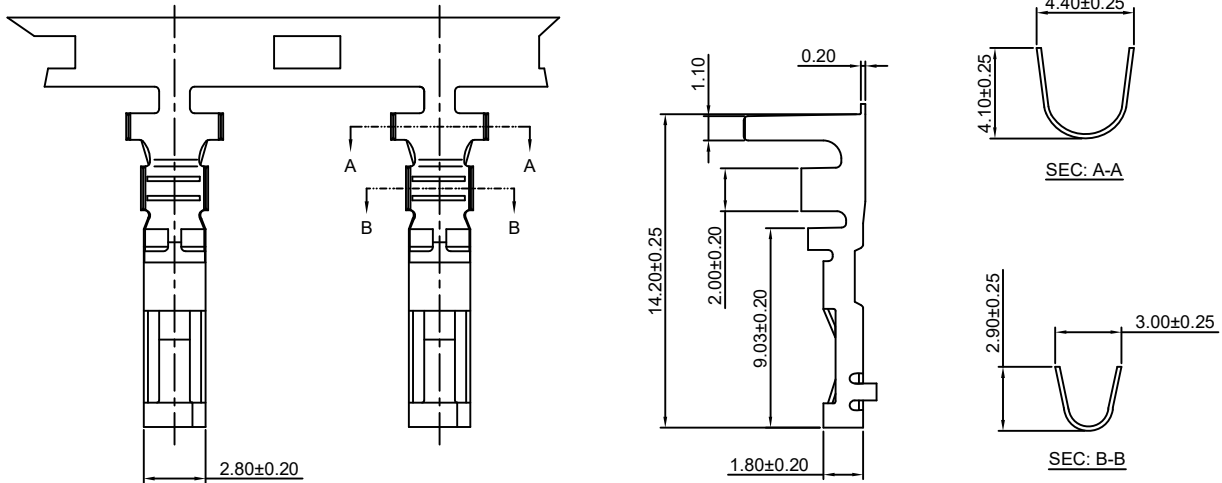

Ordering information & Specifications:

Unit:mm

Part NO.	Wire Range	Insulation O.D.	Material	Finish	Qty/reel
HDGC4501F-TP	AWG#16-#20	3.40mm(max)	Phosphor Bronze	Tin over Nickel	4,000 PCS
HDGC4501F-GP	AWG#16-#20	3.40mm(max)	Phosphor Bronze	Gold over Nickel	4,000 PCS
HDGC4501F-TP-L	AWG#20-#26	2.50mm(max)	Phosphor Bronze	Tin over Nickel	4,000 PCS
HDGC4501F-GP-L	AWG#20-#26	2.50mm(max)	Phosphor Bronze	Gold over Nickel	4,000 PCS

Optional Gold plating available but MOQ requested

HDGC4501M-T

4.50mm pitch Crimp Terminal

Reference Informations:

*Used in HDGC4501HM,HDGC4501HMA series Housing

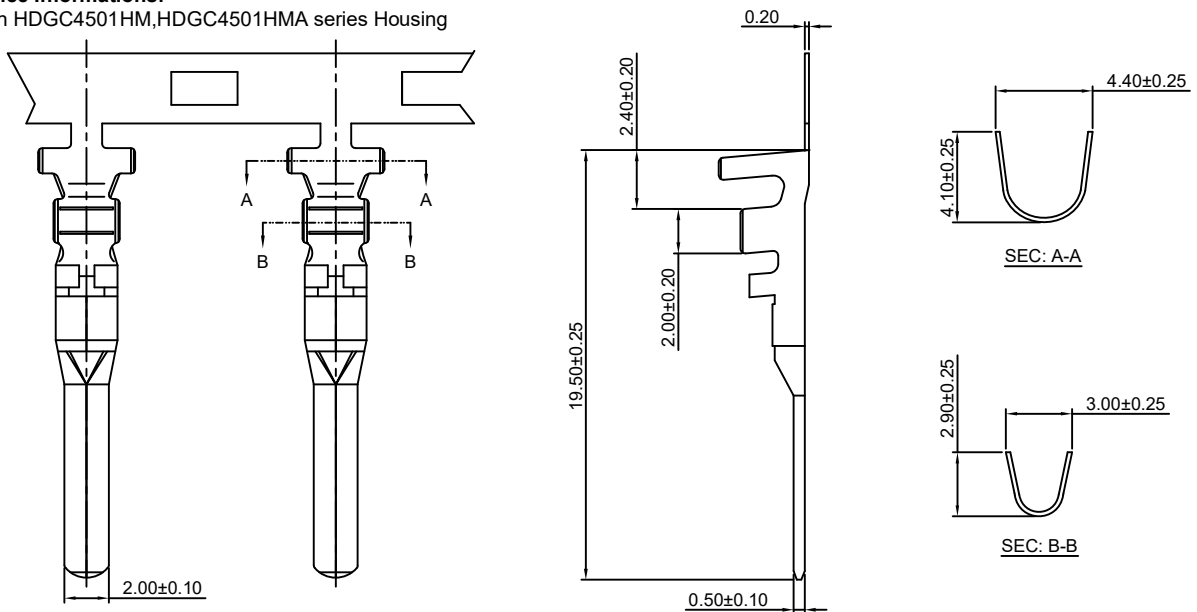

Ordering information & Specifications:

Unit:mm

Part NO.	Wire Range	Insulation O.D.	Material	Finish	Qty/reel
HDGC4501M-TP	AWG#16-#20	3.40mm(max)	Phosphor Bronze	Tin over Nickel	4,000 PCS
HDGC4501M-GP	AWG#16-#20	3.40mm(max)	Phosphor Bronze	Gold over Nickel	4,000 PCS
HDGC4501M-TP-L	AWG#20-#26	2.50mm(max)	Phosphor Bronze	Tin over Nickel	4,000 PCS
HDGC4501M-GP-L	AWG#20-#26	2.50mm(max)	Phosphor Bronze	Gold over Nickel	4,000 PCS

Optional Gold plating available but MOQ requested



HDGC4501 Series 4.50mm (.177") Pitch Wire to Wire Connector

HDGC4501H

4.50mm Pitch Housing

Reference Informations:

- *Material: Nylon 66, UL94V-0
- *Retainer Material: Nylon 66, UL94V-0
- *HDGC4501HM (Suitable Terminal: HDGC 4501M-T(-L))
- *HDGC4501HF (Suitable Terminal: HDGC4501F-T(-L))
- *Color: White
- *Retainer Color: Ivory

Ordering Information:
 HDGC4501HF-XP - ***
 1 2

- 1. Part No.
- 2. Material:
 (blank): Nylon 66, UL94V-0
 GWT: Nylon 66, UL94V-0, GWT 750°C

Ordering Information:
 HDGC4501HM<HMA>-XP - ***
 1 2

- 1. Part No.
- 2. Material:
 (blank): Nylon 66, UL94V-0
 GWT: Nylon 66, UL94V-0, GWT 750°C

Unit: mm

HDGC4501HF	HDGC4501HM<HMA>	Retainer
<p><u>HDGC4501HF-1P</u></p>	<p><u>HDGC4501HM-1P</u></p>	<p><u>HDGC4501S-1P</u></p>
<p><u>HDGC4501HF-2P</u></p>	<p><u>HDGC4501HM-2P</u></p>	<p><u>HDGC4501S-2P</u> (commonly used for 2 circuit housing and 2x2 circuit housing)</p>
	<p><u>HDGC4501HMA-2P</u></p>	
<p><u>HDGC4501HF-3P</u></p>	<p><u>HDGC4501HM-3P</u></p>	<p><u>HDGC4501S-3P</u> (commonly used for 3 circuit housing and 2x3 circuit housing)</p>
	<p><u>HDGC4501HMA-3P</u></p>	



HDGC4501 Series 4.50mm (.177") Pitch Wire to Wire Connector

HDGC4501H

4.50mm Pitch Housing

Unit: mm

HDGC4501HF	HDGC4501HM<HMA>	Retainer
<p><u>HDGC4501HF-2x2P</u></p>	<p><u>HDGC4501HM-2x2P</u></p>	<p><u>HDGC4501S-2P</u></p>
<p><u>HDGC4501HF-2x3P</u></p>	<p><u>HDGC4501HM-2x3P</u></p>	<p><u>HDGC4501S-3P</u></p>
<p><u>HDGC4501HF-2x3P</u></p>	<p><u>HDGC4501HMA-2x3P</u></p>	<p><u>HDGC4501S-3P</u></p>



HDGC4501 Series 4.50mm (.177") Pitch Wire to Wire Connector

HDGC4501H

4.50mm Pitch Housing

Unit: mm

HDGC4501HF	HDGC4501HM<HMA>	Retainer
<p><u>HDGC4501HF-2x4P</u></p> <p>Dimensions: 21.30, 8.80, 19.30±0.25, 3.40, 11.80±0.20, 4.50±0.10, 13.50±0.20, 4.50±0.10, 13.50±0.20.</p> <p>Labels: Circuit 1, Circuit 4, Last Circuit.</p>	<p><u>HDGC4501HM-2x4P</u></p> <p>Dimensions: 26.90±0.25, 3.10, 12.50±0.20, 13.50±0.20, 3.00, 3.00, 19.30±0.20, 4.50±0.10, 4.50±0.10, 19.30±0.20.</p> <p>Labels: Circuit 1, Circuit 4, Last Circuit.</p> <p><u>HDGC4501HMA-2x4P</u></p> <p>Dimensions: 26.90±0.25, 3.10, 12.50±0.20, 13.50±0.20, 3.00, 3.00, 19.30±0.20, 4.50±0.10, 4.50±0.10, 19.30±0.20.</p> <p>Labels: Circuit 1, Circuit 4, Last Circuit.</p>	<p><u>HDGC4501S-4P</u></p> <p>Dimensions: 11.50±0.25, 19.20±0.25, 2.90, 13.50±0.20.</p>
<p><u>HDGC4501HF-2x6P</u></p> <p>Dimensions: 21.30±0.25, 8.80, 28.30±0.25, 3.40, 11.80±0.20, 4.50±0.10, 22.50±0.20, 4.50±0.10, 22.50±0.20.</p> <p>Labels: Circuit 1, Circuit 6, Last Circuit.</p>	<p><u>HDGC4501HM-2x6P</u></p> <p>Dimensions: 26.90±0.25, 3.10, 12.50±0.20, 22.50±0.20, 4.50±0.10, 3.00, 3.00, 28.30±0.20, 4.50±0.10, 4.50±0.10, 28.30±0.20.</p> <p>Labels: Circuit 1, Circuit 6, Last Circuit.</p>	<p><u>HDGC4501S-6P</u></p> <p>Dimensions: 11.50±0.25, 26.30±0.25, 2.90, 22.50±0.20.</p>
<p><u>HDGC4501HF-2x8P</u></p> <p>Dimensions: 21.30±0.25, 8.80, 37.30±0.25, 3.40, 11.80±0.20, 4.50±0.10, 31.50±0.20, 4.50±0.10, 31.50±0.20.</p> <p>Labels: Circuit 1, Circuit 8, Last Circuit.</p>	<p><u>HDGC4501HM-2x8P</u></p> <p>Dimensions: 26.90±0.25, 3.10, 12.50±0.20, 31.50±0.20, 4.50±0.10, 3.00, 3.00, 37.30±0.20, 4.50±0.10, 4.50±0.10, 37.30±0.20.</p> <p>Labels: Circuit 1, Circuit 8, Last Circuit.</p>	<p><u>HDGC4501S-8P</u></p> <p>Dimensions: 11.50±0.25, 37.00±0.25, 2.90, 31.50±0.20.</p>



HDGC4501 Series 4.50mm (.177") Pitch Wire to Wire Connector

HDGC4501H

4.50mm Pitch Housing

Unit: mm

HDGC4501HF	HDGC4501HM	Retainer
<p><u>HDGC4501HF-3x3P</u></p>	<p><u>HDGC4501HM-3x3P</u></p>	
<p><u>HDGC4501HF-3x4P</u></p>	<p><u>HDGC4501HM-3x4P</u></p>	
<p><u>HDGC4501HF-3x5P</u></p>	<p><u>HDGC4501HM-3x5P</u></p>	