

Specifications

- Current rating: 1A AC, DC
- Voltage rating: 600V AC, DC
- Temperature range: -25°C ~ +85°C
- Contact resistance: 10mΩ Max.
- Insulation resistance: 1000MΩ Min.
- Withstanding voltage: 1800V AC/minute
- *Compliant with RoHS and REACH*
- *Meet the HF/Halogen Free, GWT/Glow wire Test (IEC60335-1) request, need to customize*
- *Contact HDGC for details*

Assembly layout

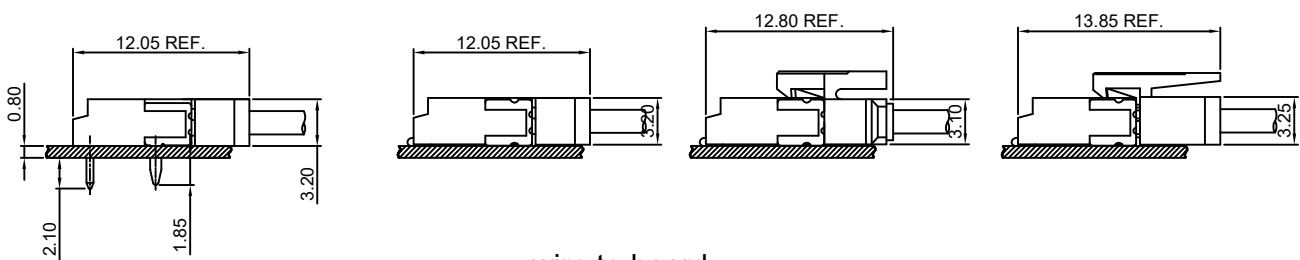

wire to board

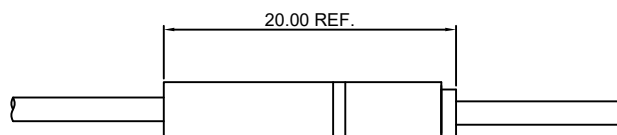

wire to wire



HDGC4001 Series 4.00mm (.157") Pitch Wire to Board and Wire to Wire Connector

HDGC4001-T

4.00mm pitch Crimp Terminal

Reference Informations:

*Used in HDGC4001H, HC-XP series Housing

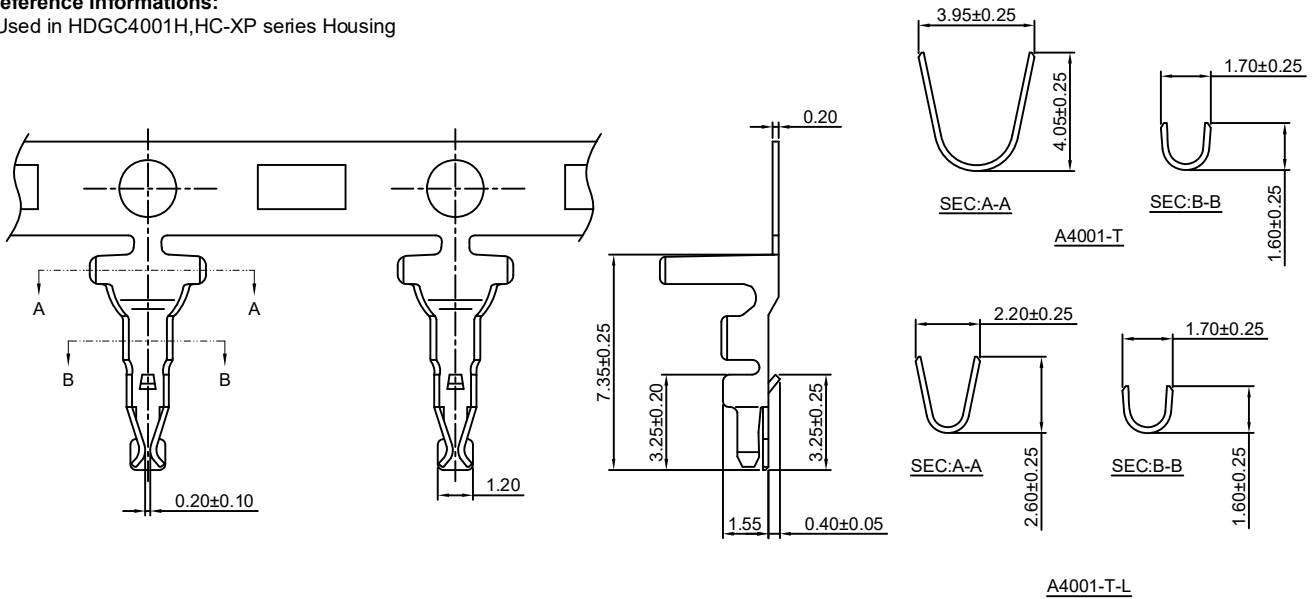

Ordering information & Specifications:

Unit:mm

Part NO.	Wire Range	Insulation O.D.	Material	Finish	Qty/reel
HDGC4001-TP	AWG#18-#22	3.00mm(max)	Phosphor Bronze	Tin over Nickel	5,000 PCS
HDGC4001-GP	AWG#18-#22	3.00mm(max)	Phosphor Bronze	Gold over Nickel	5,000 PCS
HDGC4001-TP-L	AWG#22-#28	1.60mm(max)	Phosphor Bronze	Tin over Nickel	8,000 PCS
HDGC4001-GP-L	AWG#22-#28	1.60mm(max)	Phosphor Bronze	Gold over Nickel	8,000 PCS

Optional Gold plating available but MOQ requested

HDGC4001M-T

4.00mm pitch Crimp Terminal

Reference Informations:

*Used in HDGC4001HM-XP series Housing

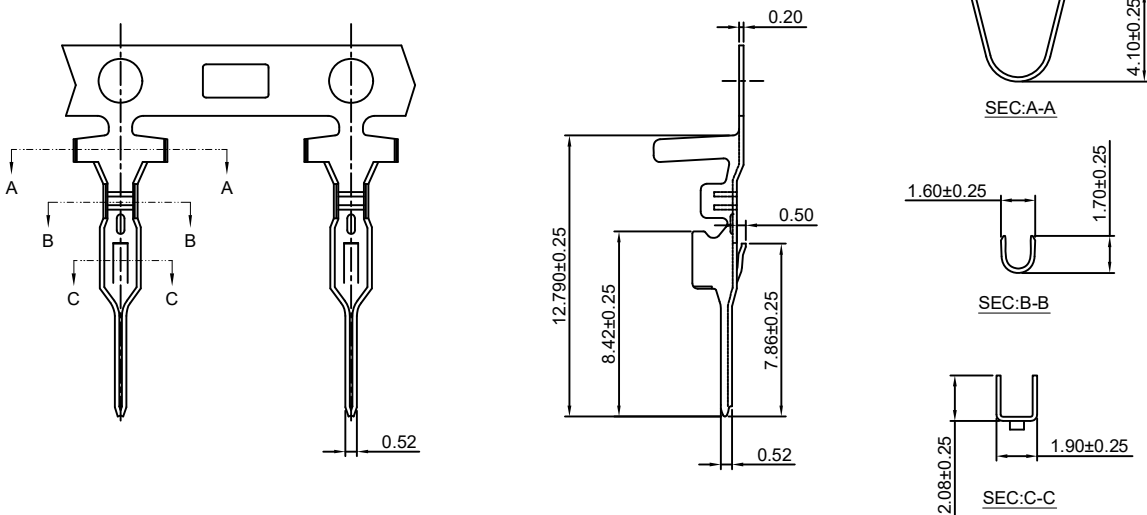

Ordering information & Specifications:

Unit:mm

Part NO.	Wire Range	Insulation O.D.	Material	Finish	Qty/reel
HDGC4001M-TP	AWG#22-#28	2.40mm(max)	Phosphor Bronze	Tin over Nickel	5,000 PCS
HDGC4001M-GP	AWG#22-#28	2.40mm(max)	Phosphor Bronze	Gold over Nickel	5,000 PCS

Optional Gold plating available but MOQ requested



HDGC4001 Series 4.00mm (.157") Pitch Wire to Board and Wire to Wire Connector

HDGC4001A-T

4.00mm pitch Crimp Terminal

Reference Informations:

*Used in HDGC4001HA,HB-XP series Housing

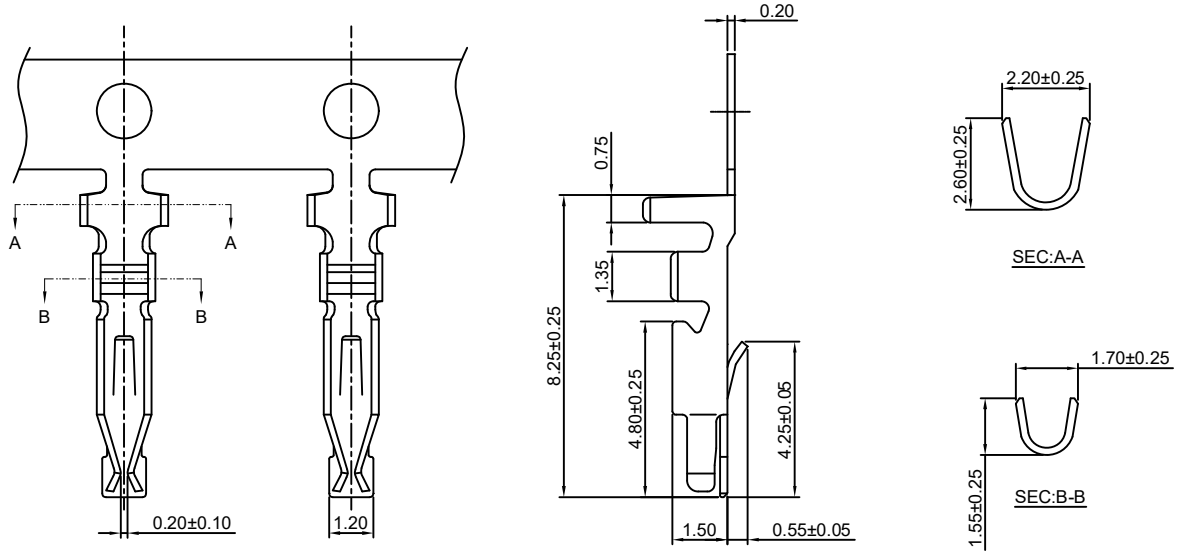

Ordering information & Specifications:

Unit:mm

Part NO.	Wire Range	Insulation O.D.	Material	Finish	Qty/reel
HDGC4001A-TP	AWG#24-#28	1.60mm(max)	Phosphor Bronze	Tin over Nickel	10,000 PCS
HDGC4001A-GP	AWG#24-#28	1.60mm(max)	Phosphor Bronze	Gold over Nickel	10,000 PCS

Optional Gold plating available but MOQ requested

HDGC4001H-XP

4.00mm pitch Housing

Reference Informations:

*Material:Nylon 66,UL94V-0

*Suitable HDGC4001-T series Terminal

*Mates with HDGC4001HM-XP series Housing

or HDGC4001WR,WRA-XP,WR-S,WRA-S-XP series Wafer

*Color:White

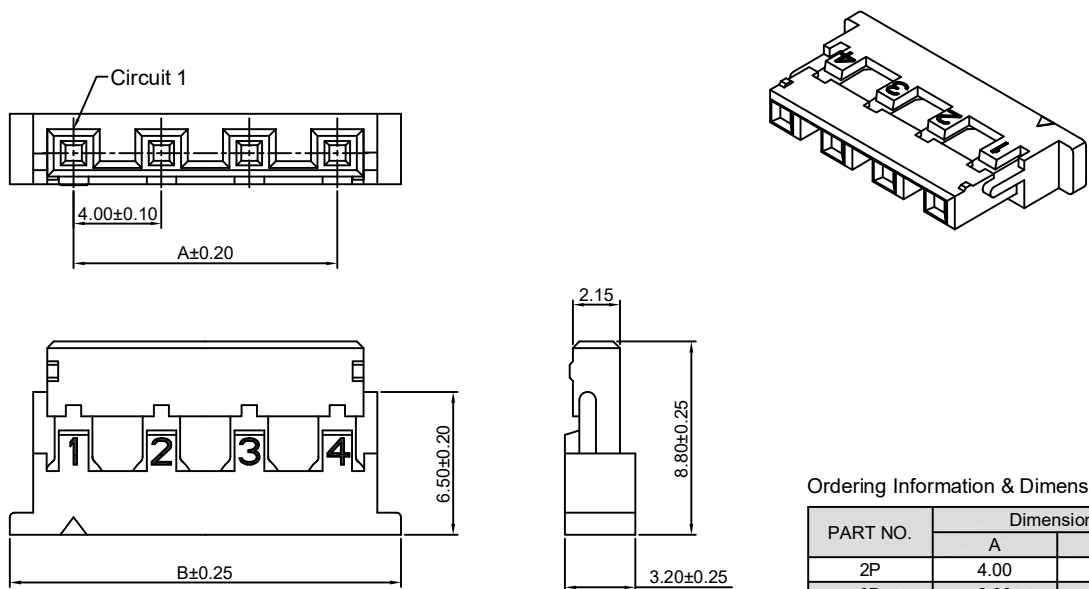

Ordering Information & Dimensions:

PART NO.	Dimensions	
	A	B
2P	4.00	9.80
3P	8.00	13.80
4P	12.00	17.80
5P	16.00	21.80

Unit: mm



HDGC4001 Series 4.00mm (.157") Pitch Wire to Board and Wire to Wire Connector

HDGC4001HA-XP

4.00mm pitch Housing

Reference Informations:

- *Material:Nylon 66,UL94V-0
- *Suitable HDGC4001A-T series Terminal
- *Mates with HDGC4001HMA-XP or HDGC4001WRA-XP,HDGC4001WRA-S-XP series Wafer
- *Color:White

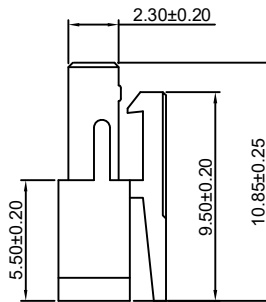
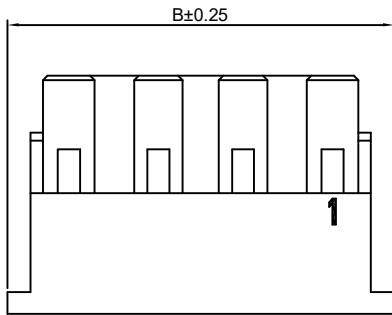
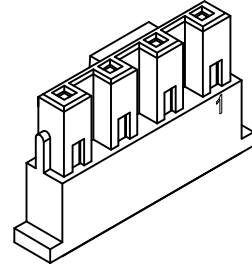
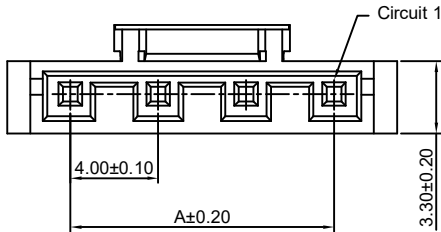

Ordering Information & Dimensions:

PART NO.	Dimensions	
	A	B
2P	4.00	9.80
3P	8.00	13.80
4P	12.00	17.80
5P	16.00	21.80

Unit: mm

HDGC4001HB-XP

4.00mm pitch Housing

Reference Informations:

- *Material:Nylon 66,UL94V-0
- *Suitable HDGC4001A-T series Terminal
- *Mates with HDGC4001HMA-XP or WRA-XP,WRA-S-XP series Wafer
- *Color:White

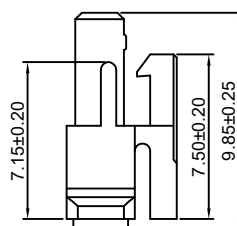
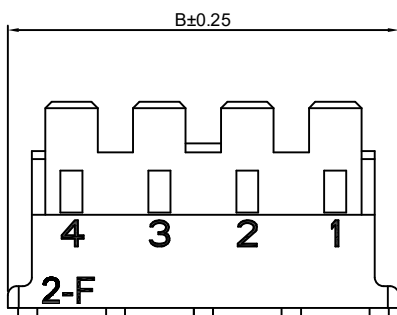
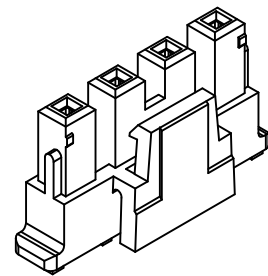
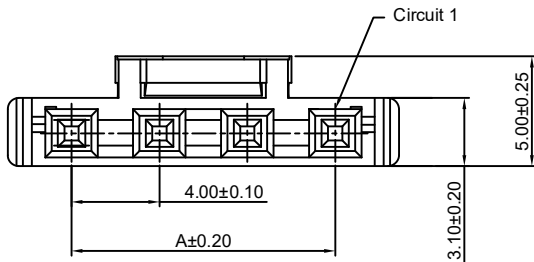

Ordering Information & Dimensions:

PART NO.	Dimensions	
	A	B
2P	4.00	9.80
3P	8.00	13.80
4P	12.00	17.80
5P	16.00	21.80

Unit: mm



HDGC4001 Series 4.00mm (.157") Pitch Wire to Board and Wire to Wire Connector

HDGC4001HC-XP

4.00mm pitch Housing

Reference Informations:

- *Material:Nylon 66,UL94V-0
- *Suitable HDGC4001-T series Terminal
- *Mates with HDGC4001HM-XP series Housing
- *Color:White

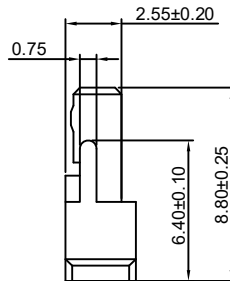
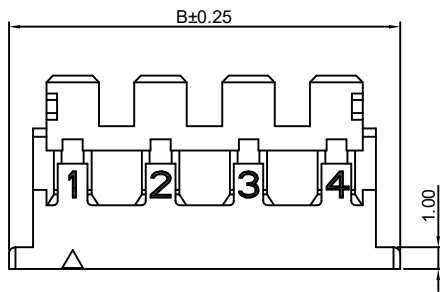
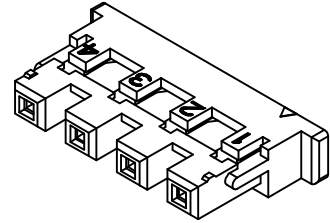
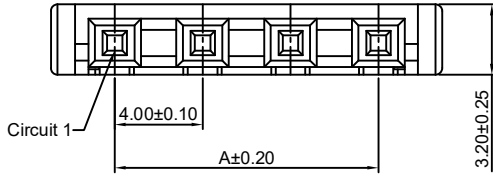

Ordering Information & Dimensions:

PART NO.	Dimensions	
	A	B
2P	4.00	9.80
3P	8.00	13.80
4P	12.00	17.80
5P	16.00	21.80

Unit: mm

HDGC4001H-XP-A

4.00mm pitch Housing

Reference Informations:

- *Material:Nylon 66,UL94V-0
- *Suitable HDGC4001 series Terminal
- *Mates with HDGC4001HM series Housing
- *Color:White

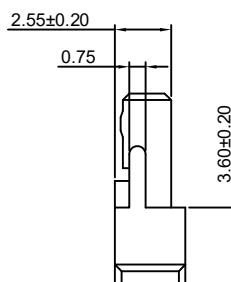
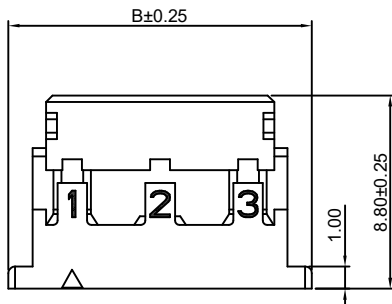
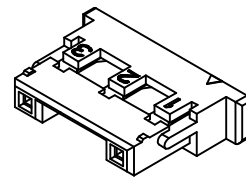
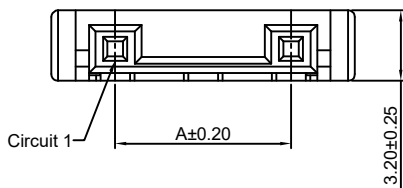

Ordering Information & Dimensions:

PART NO.	Dimensions	
	A	B
3P	8.00	13.80
5P	16.00	21.80

Unit: mm



HDGC4001 Series 4.00mm (.157") Pitch Wire to Board and Wire to Wire Connector

HDGC4001HM-XP

4.00mm pitch Housing

Reference Informations:

- *Material:Nylon 66,UL94V-0
- *Suitable HDGC4001M-T series Terminal
- *Mates with HDGC4001H,HC-XP,H-XP-A series Housing
- *Color:White

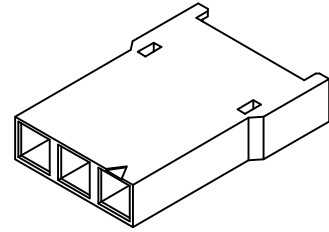
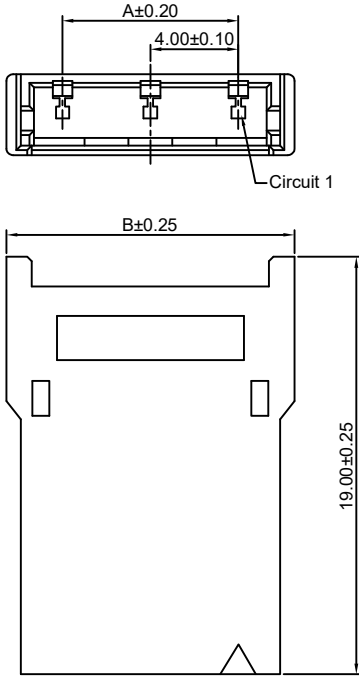

Ordering Information & Dimensions:

PART NO.	Dimensions	
	A	B
2P	4.00	9.10
3P	8.00	13.10
4P	12.00	17.10
5P	16.00	21.10

Unit: mm

HDGC4001HMA-XP

4.00mm pitch Housing

Reference Informations:

- *Material:Nylon 66,UL94V-0
- *Suitable HDGC4001M-T series Terminal
- *Mates with HDGC4001HA,HB-XP series Housing
- *Color:White

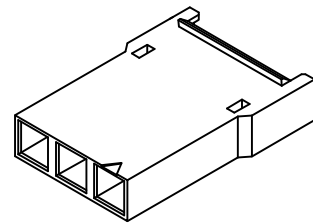
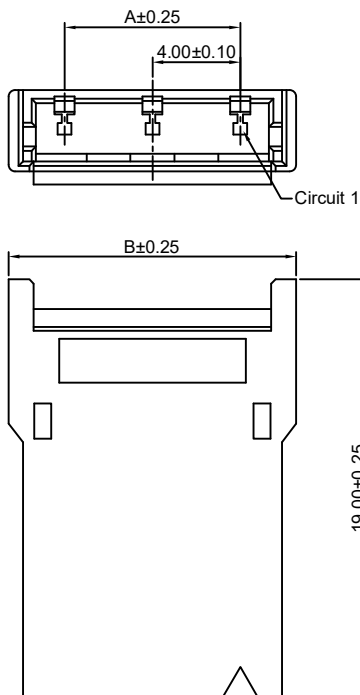

Ordering Information & Dimensions:

PART NO.	Dimensions	
	A	B
2P	4.00	9.10
3P	8.00	13.10
4P	12.00	17.10
5P	16.00	21.10

Unit: mm



HDGC4001 Series 4.00mm (.157") Pitch Wire to Board and Wire to Wire Connector

HDGC4001WR-XP

4.00mm pitch 90° Wafer-DIP TYPE

Reference Informations:

- *Material: Pin: Brass/Tin over Nickel
Solder Pin: Brass/Tin over Nickel
Insulator: Nylon 6T, UL94V-0
- *Mates with HDGC4001H-XP series Housing
- *Color: Beige

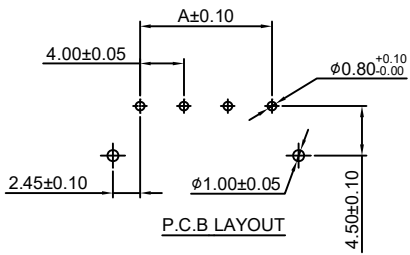
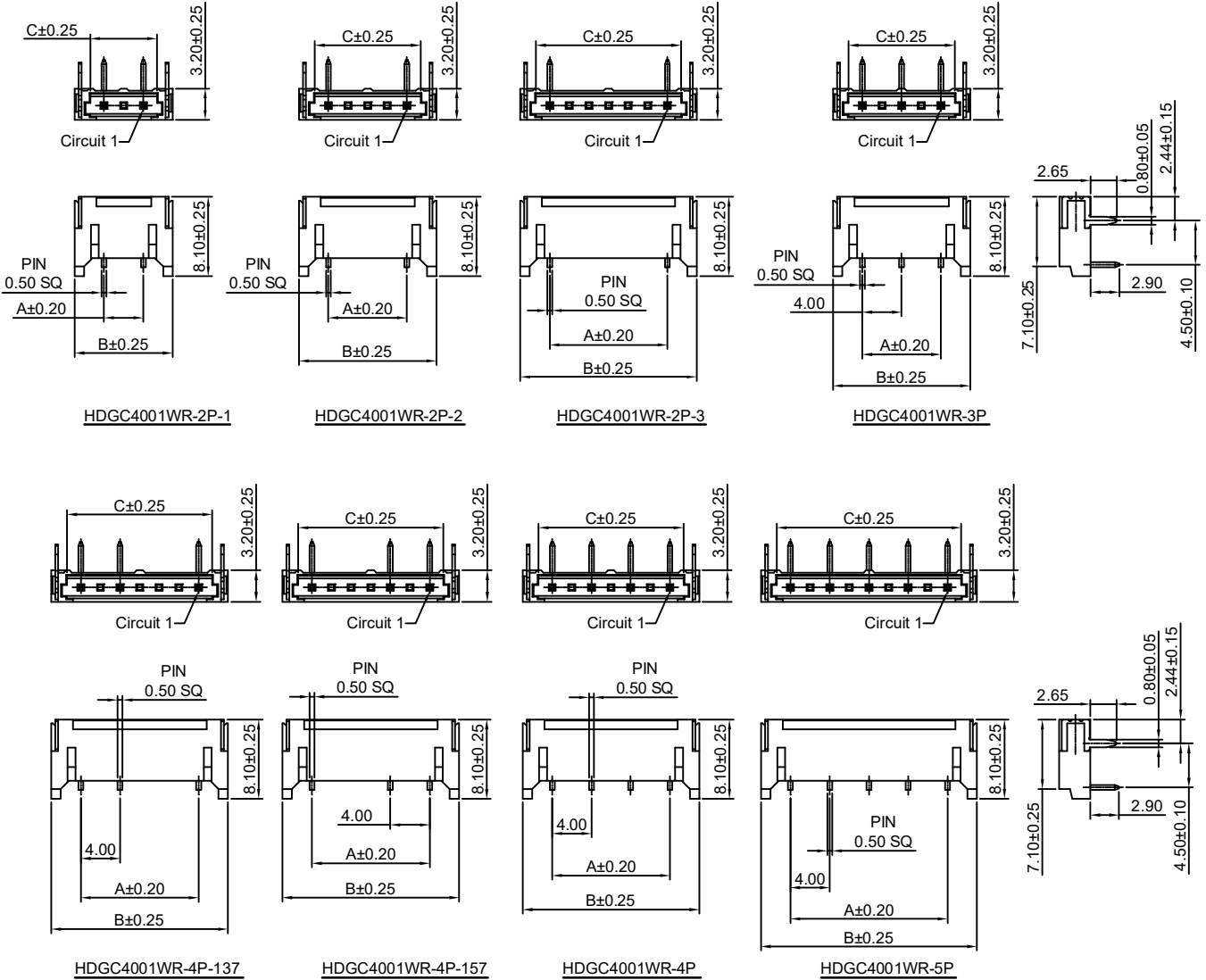
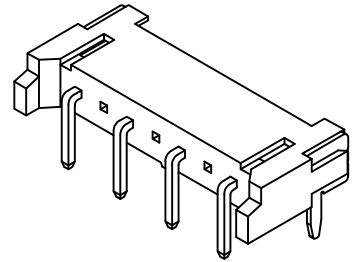

Ordering Information & Dimensions:

PART NO.	Dimensions		
	A	B	C
2P-1	4.00	10.00	6.80
2P-2	8.00	14.00	10.80
2P-3	12.00	18.00	14.80
3P	8.00	14.00	10.80
4P-137	12.00	18.00	14.80
4P-157	12.00	18.00	14.80
4P	12.00	18.00	14.80
5P	16.00	22.00	18.80

Unit: mm



HDGC4001 Series 4.00mm (.157") Pitch Wire to Board and Wire to Wire Connector

HDGC4001WRA-XP

4.00mm pitch 90° Wafer-DIP TYPE

Reference Informations:

- *Material: Pin: Brass/Tin over Nickel
Solder Pin: Brass/Tin over Nickel
Insulator: Nylon 6T, UL94V-0
- *Mates with HDGC4001HA, HB-XP series Housing
- *Color: Beige

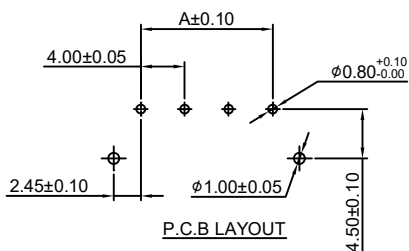
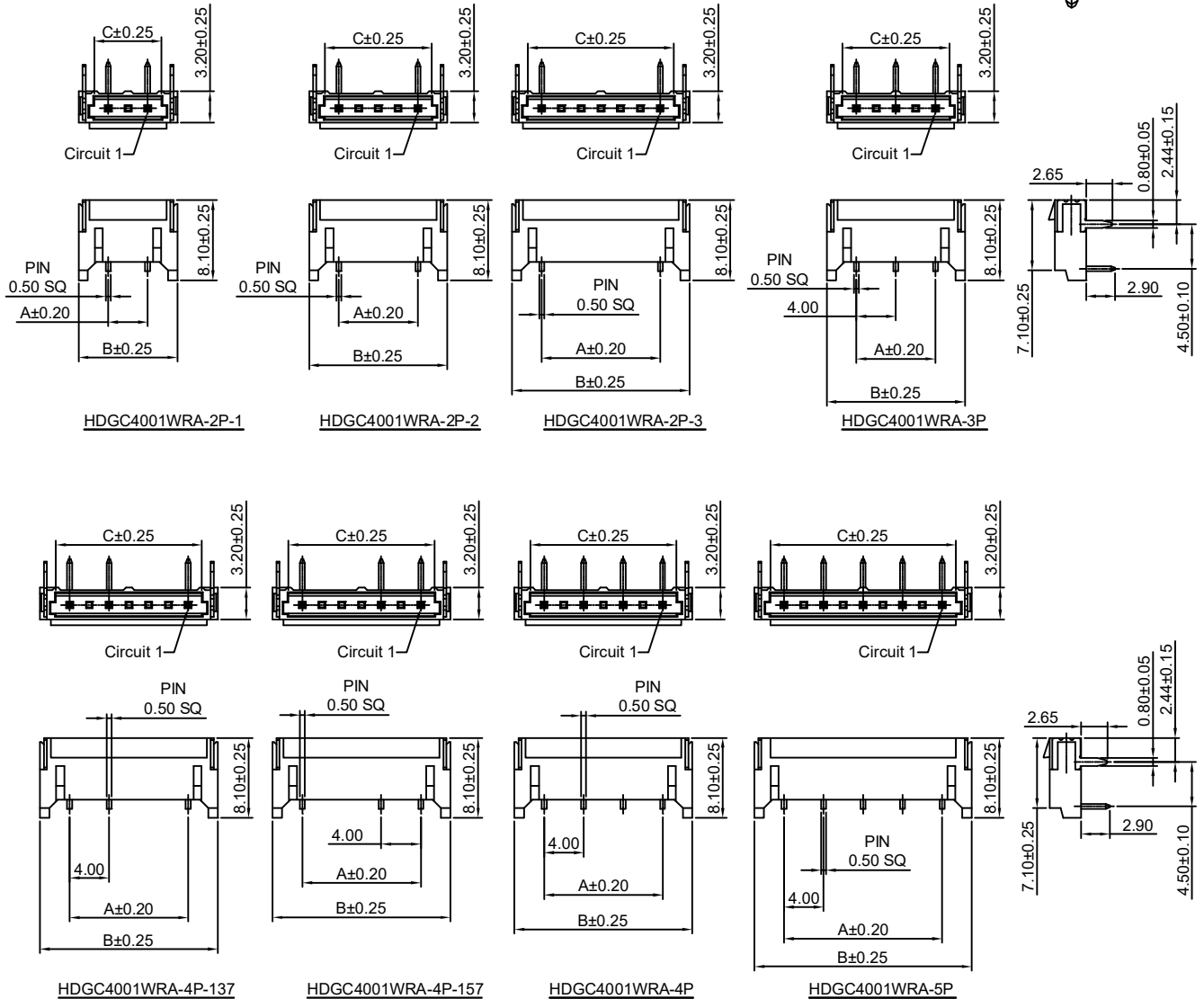
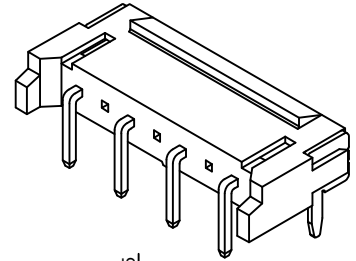

Ordering Information & Dimensions:

PART NO.	Dimensions		
	A	B	C
2P-1	4.00	10.00	6.80
2P-2	8.00	14.00	10.80
2P-3	12.00	18.00	14.80
3P	8.00	14.00	10.80
4P-137	12.00	18.00	14.80
4P-157	12.00	18.00	14.80
4P	12.00	18.00	14.80
5P	16.00	22.00	18.80

Unit: mm



HDGC4001 Series 4.00mm (.157") Pitch Wire to Board and Wire to Wire Connector

HDGC4001WR-S-XP

4.00mm pitch 90° Wafer-SMT TYPE

Reference Informations:

- *Material:Pin:Brass/Tin over Nickel
Solder Tabs:Brass/Tin over Nickel
Insulator:Nylon 6T,UL94V-0
- *Mates with HDGC4001H-XP series Housing
- *Color:Beige

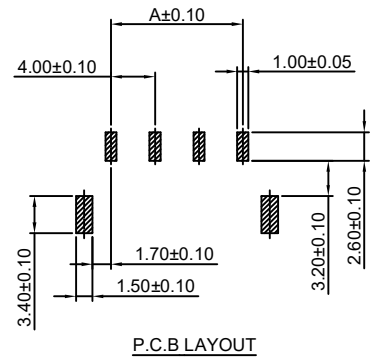
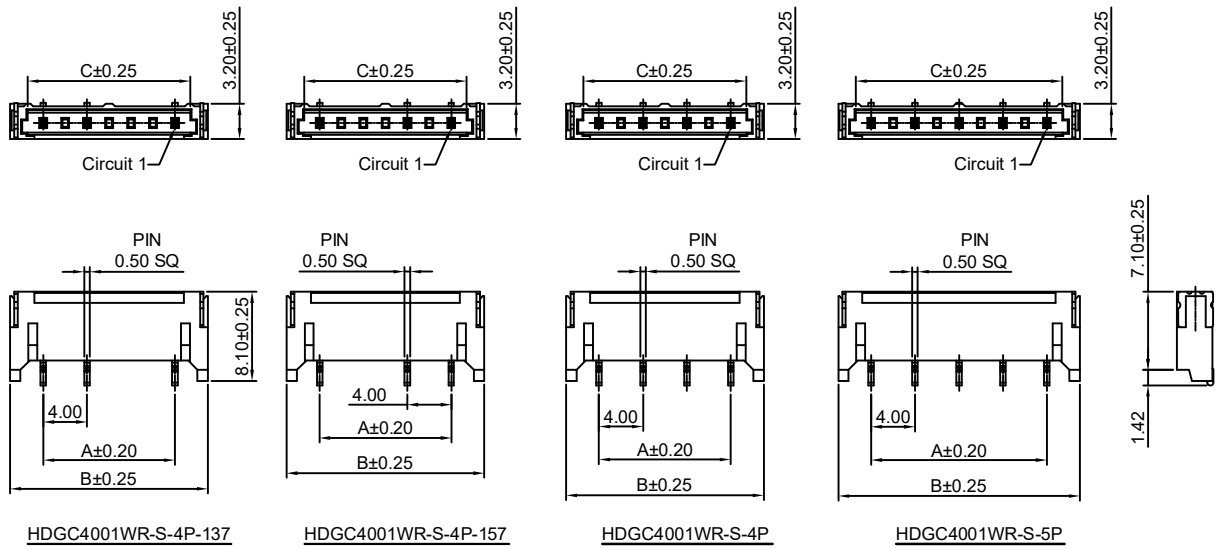
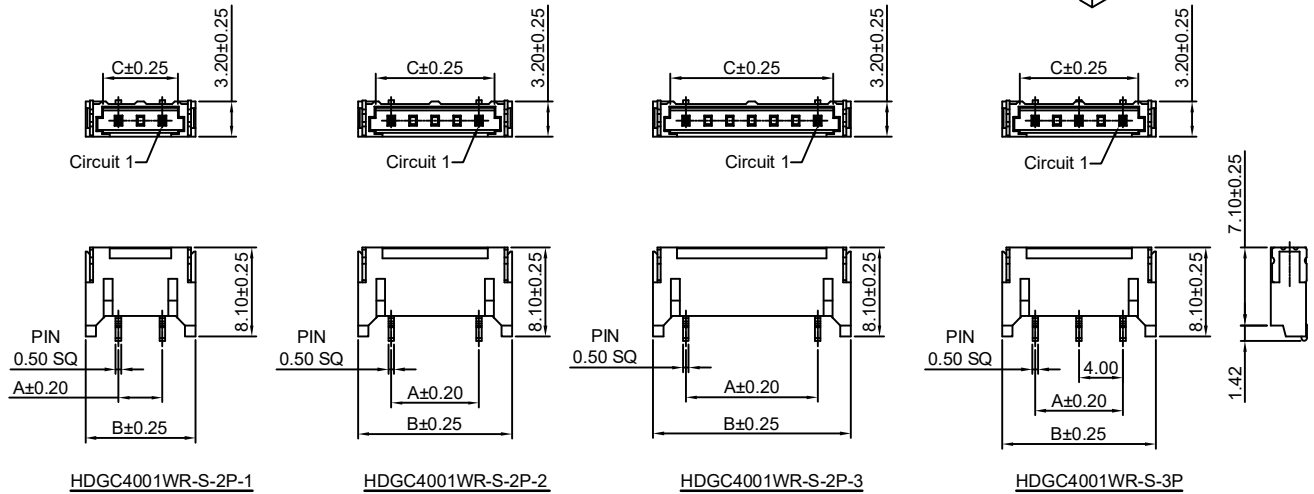
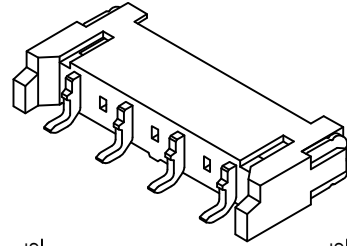

Ordering Information & Dimensions:

PART NO.	Dimensions		
	A	B	C
2P-1	4.00	10.00	6.80
2P-2	8.00	14.00	10.80
2P-3	12.00	18.00	14.80
3P	8.00	14.00	10.80
4P-137	12.00	18.00	14.80
4P-157	12.00	18.00	14.80
4P	12.00	18.00	14.80
5P	16.00	22.00	18.80

Unit: mm



HDGC4001 SERIES



HDGC4001 Series 4.00mm (.157") Pitch Wire to Board and Wire to Wire Connector

HDGC4001WRA-S-XP

4.00mm pitch 90° Wafer-SMT TYPE

Reference Informations:

*Material:Pin:Brass/Tin over Nickel

Solder Tabs:Brass/Tin over Nickel

Insulator:Nylon 6T,UL94V-0

*Mates with HDGC4001HA,HB-XP series Housing

*Color:Beige

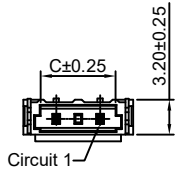
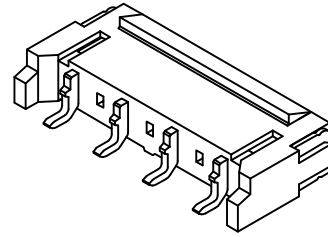

Circuit 1

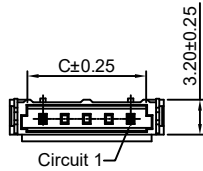

Circuit 1

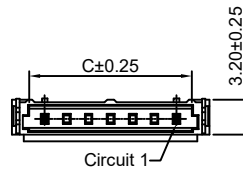

Circuit 1

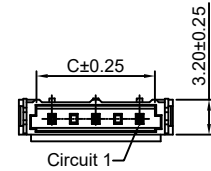

Circuit 1

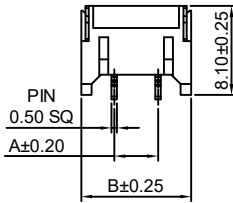

HDGC4001WRA-S-2P-1

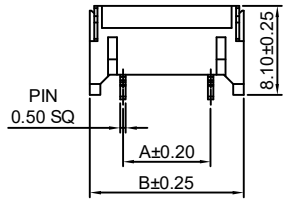

HDGC4001WRA-S-2P-2

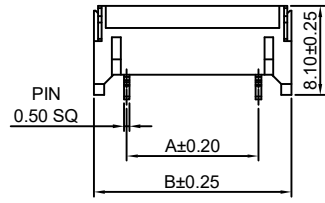

HDGC4001WRA-S-2P-3

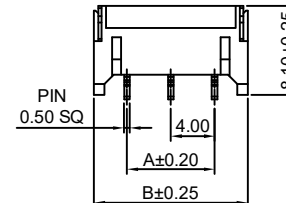

HDGC4001WRA-S-3P

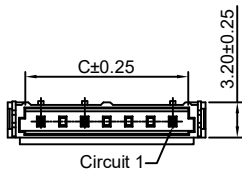
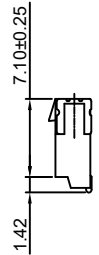

Circuit 1

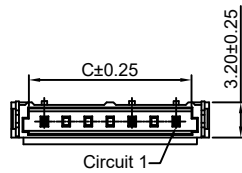

Circuit 1

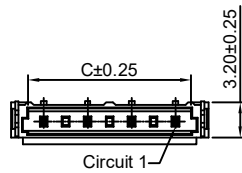

Circuit 1

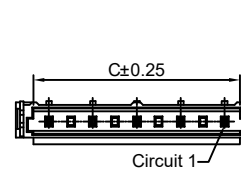

Circuit 1

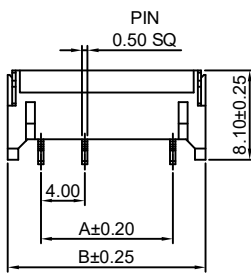

HDGC4001WRA-S-4P-137

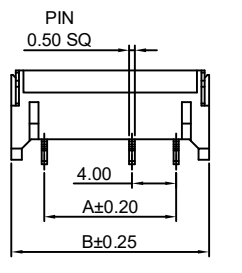

HDGC4001WRA-S-4P-157

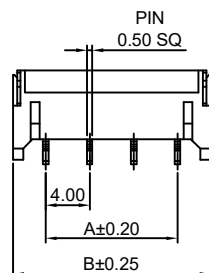

HDGC4001WRA-S-4P

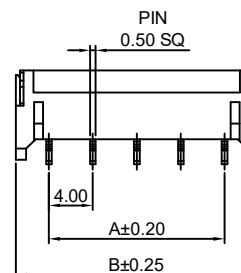

HDGC4001WRA-S-5P

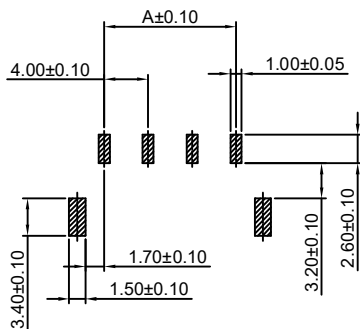
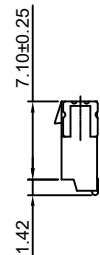

P.C.B LAYOUT

Ordering Information & Dimensions:

PART NO.	Dimensions		
	A	B	C
2P-1	4.00	10.00	6.80
2P-2	8.00	14.00	10.80
2P-3	12.00	18.00	14.80
3P	8.00	14.00	10.80
4P-137	12.00	18.00	14.80
4P-157	12.00	18.00	14.80
4P	12.00	18.00	14.80
5P	16.00	22.00	18.80

Unit: mm