

Specifications

- Current rating: 1A AC, DC
- Voltage rating: 1400V AC, DC
- Temperature range: -25°C ~ +85°C
- Contact resistance: 10mΩ Max.
- Insulation resistance: 1000MΩ Min.
- Withstanding voltage: 3800V AC/minute
- *Compliant with RoHS and REACH*
- *Meet the HF/Halogen Free, GWT/Glow wire Test (IEC60335-1) request, need to customize*
- *Contact HDGC for details*

Assembly layout

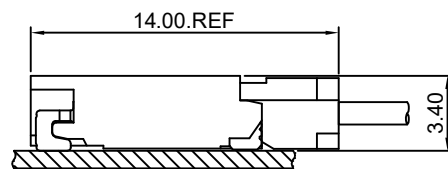

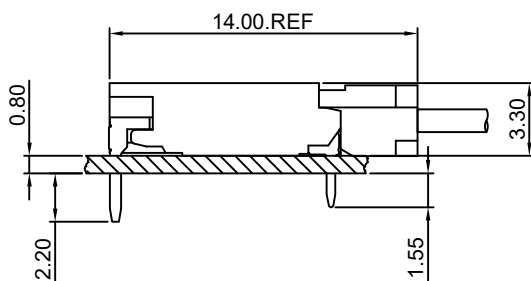

HDGC3500 Series 3.50mm (.138") Pitch Wire to Board Connector

HDGC3500-T

3.50mm Pitch Crimp Terminal

Reference Informations:

*Used in HDGC3500H,HA-2P series Housing

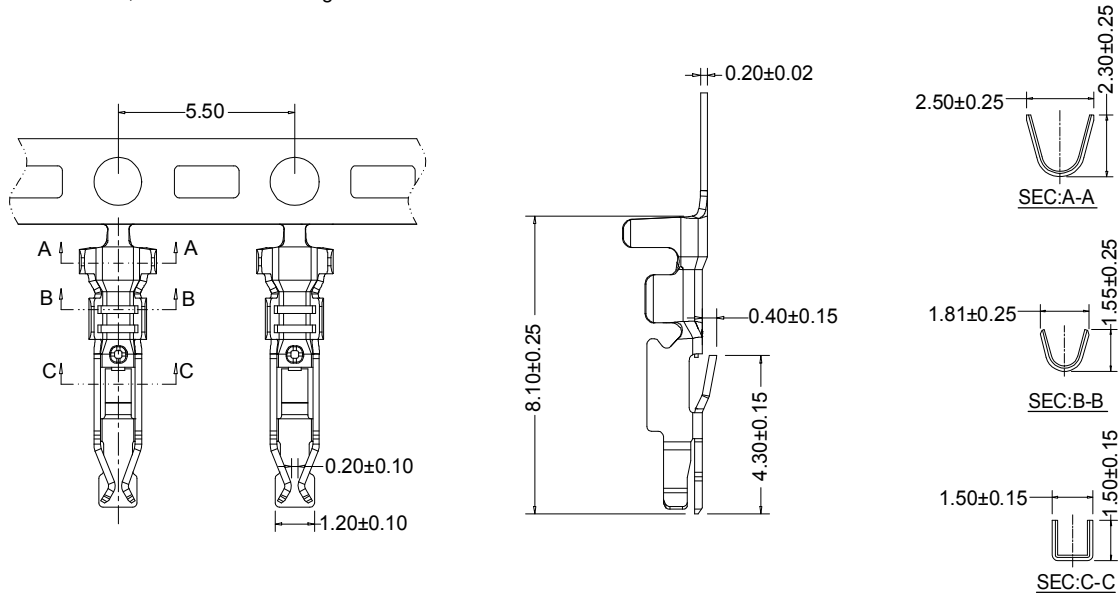

Ordering information & Specifications:

Unit:mm

Part NO.	Wire Range	Insulation O.D.	Material	Finish	Qty/reel
HDGC3500-TP	AWG#24-#28	1.60mm(max)	Phosphor Bronze	Tin over Nickel	10,000 PCS
HDGC3500-GP	AWG#24-#28	1.60mm(max)	Phosphor Bronze	Gold over Nickel	10,000 PCS

Optional Gold plating available but MOQ requested

HDGC3500M-T

3.50mm Pitch Crimp Terminal

Reference Informations:

*Used in HDGC3500HM,HMA-2P series Housing

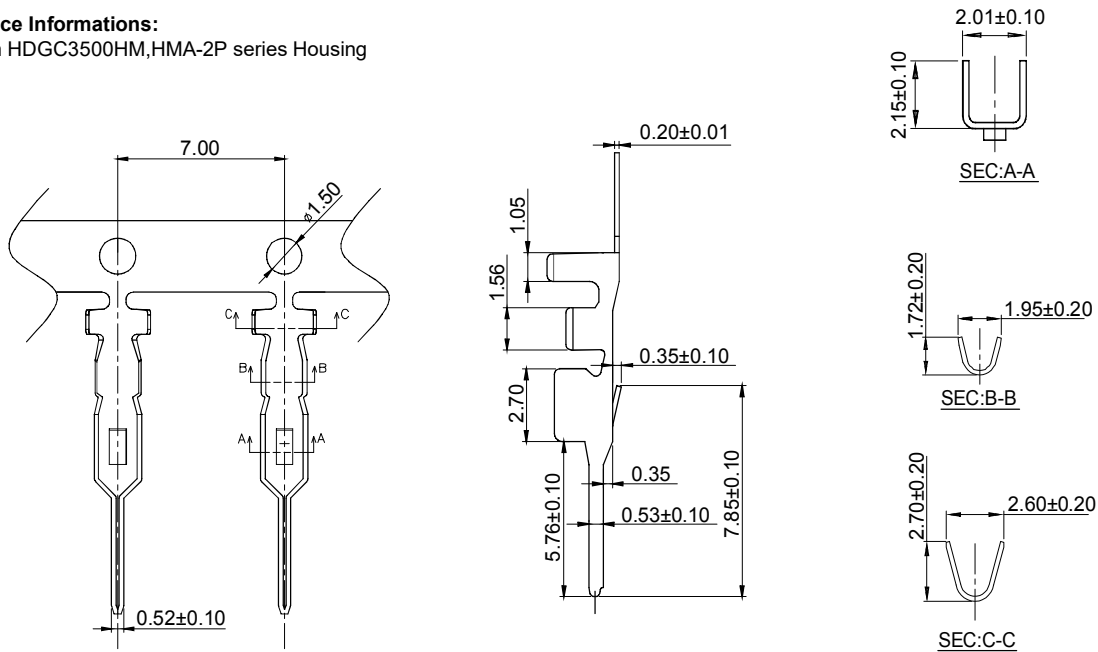

Ordering information & Specifications:

Unit:mm

Part NO.	Wire Range	Insulation O.D.	Material	Finish	Qty/reel
HDGC3500M-TP	AWG#24-#28	1.80mm(max)	Phosphor Bronze	Tin over Nickel	5,000 PCS
HDGC3500M-GP	AWG#24-#28	1.80mm(max)	Phosphor Bronze	Gold over Nickel	5,000 PCS

Optional Gold plating available but MOQ requested



HDGC3500 Series 3.50mm (.138") Pitch Wire to Board Connector

HDGC3500H-2P

3.50mm Pitch Housing

Reference Informations:

- *Material: Nylon 66 , UL94V-0
- *Suitable HDGC3500-T series Terminal
- *Mates with HDGC3500HM-2P series Housing or HDGC3500WR-2P, HDGC3500WR-S-2P series Wafer
- *Color: White

Ordering Information:
HDGC3500H-2P - ^{***}/₂ - ^{**}/₃

1. Part No.
2. Material:
 (blank): Nylon 66, UL94V-0
 GWT: Nylon 66, UL94V-0, GWT 750°C
3. Color:
 (blank): White
 GY: Gray

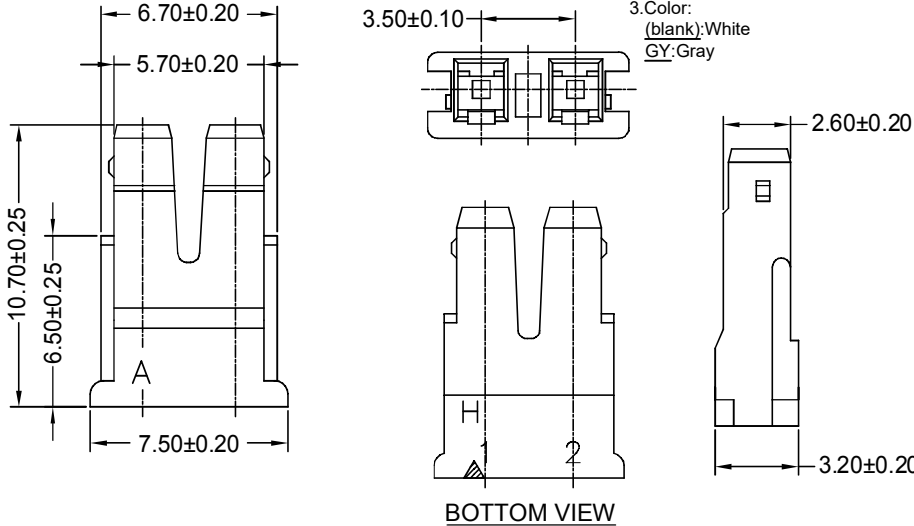
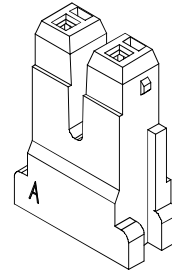

Unit: mm

HDGC3500HA-2P

3.50mm Pitch Housing

Reference Informations:

- *Material: Nylon 66 , UL94V-0
- *Suitable HDGC3500-T series Terminal
- *Mates with HDGC3500HMA-2P series Housing or HDGC3500WRA-2P, WRA-S-2P series Wafer
- *Color: White

Ordering Information:
HDGC3500HA-2P - ^{***}/₂ - ^{**}/₃

1. Part No.
2. Material:
 (blank): Nylon 66, UL94V-0
 GWT: Nylon 66, UL94V-0, GWT 750°C
3. Color:
 (blank): White
 GY: Gray

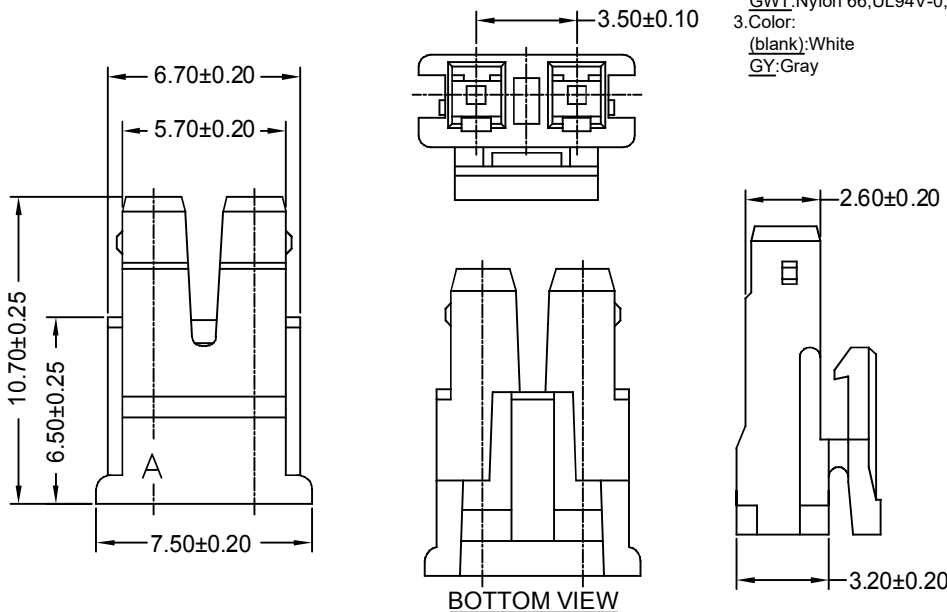
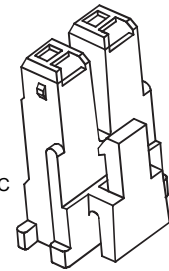

Unit: mm



HDGC3500 Series 3.50mm (.138") Pitch Wire to Board Connector

HDGC3500HM-2P

3.50mm Pitch Housing

Reference Informations:

- *Material:Nylon 66 , UL94V-0
- *Suitable HDGC3500M-T series Terminal
- *Mates with HDGC3500H-2P series Housing
- *Color:White

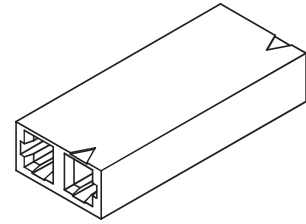
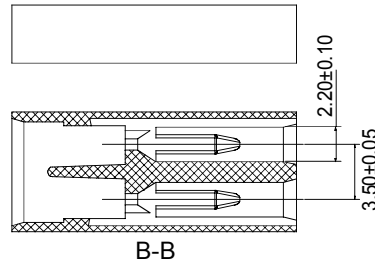
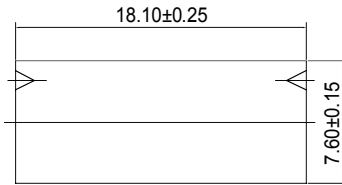
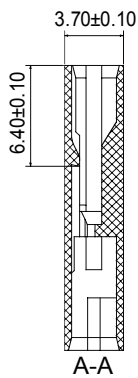
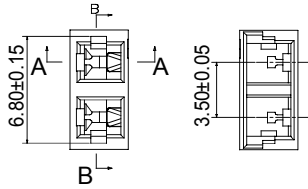

Ordering Information:

HDGC3500HM-2P - *** - **
1 2 3

- 1.Part No.
- 2.Material:
(blank):Nylon 66,UL94V-0
GWT:Nylon 66,UL94V-0,GWT 750°C
- 3.Color:
(blank):White
GY:Gray

Unit: mm

HDGC3500HMA-2P

3.50mm Pitch Housing

Reference Informations:

- *Material:Nylon 66 , UL94V-0
- *Suitable HDGC3500M-T series Terminal
- *Mates with HDGC3500HA-2P series Housing
- *Color:White

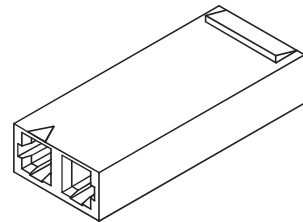
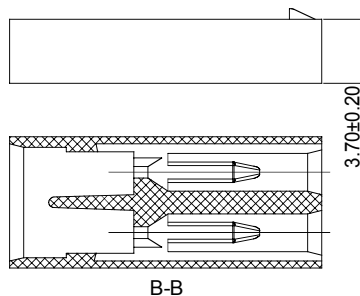
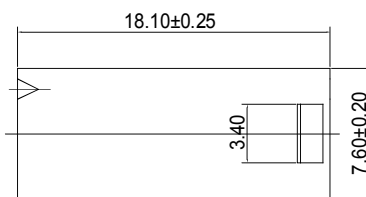
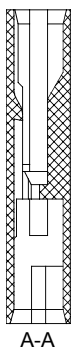
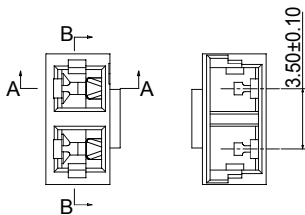

Ordering Information:

HDGC3500HMA-2P - *** - **
1 2 3

- 1.Part No.
- 2.Material:
(blank):Nylon 66,UL94V-0
GWT:Nylon 66,UL94V-0,GWT 750°C
- 3.Color:
(blank):White
GY:Gray

Unit: mm



HDGC3500 Series 3.50mm (.138") Pitch Wire to Board Connector

HDGC3500WR-2P

3.50mm Pitch 90° Wafer

Reference Informations:

- *Material:Pin:Barss/Tin over Nickel
Solder Pin:Barss/Tin over Nickel
Insulator:Nylon 6T , UL94V-0
- *Mates with HDGC3500H-2P series Housing
- *Color:White

Ordering Information:

- HDGC3500WR-2P - ***
1 2
- 1.Part No.
 - 2.Material:
(blank);Nylon 6T,UL94V-0
GWT:Nylon 6T,UL94V-0,GWT 750°C

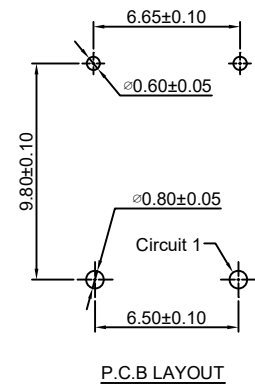
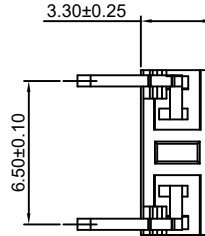
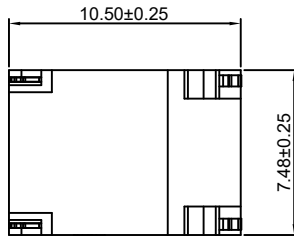
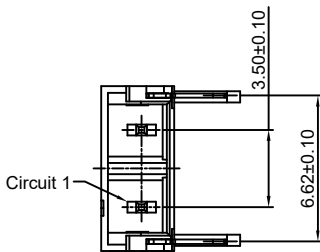
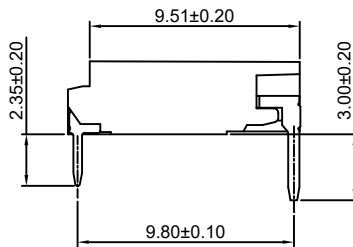
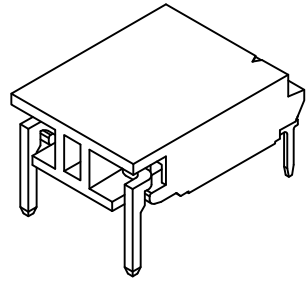

Unit: mm

HDGC3500WR-S-2P

3.50mm Pitch 90° Wafer-SMY TYPE

Reference Informations:

- *Material:Pin:Barss/Tin over Nickel
Solder Tabs:Barss/Tin over Nickel
Insulator:Nylon 6T , UL94V-0
- *Mates with HDGC3500H-2P series Housing
- *Color:White

Ordering Information:

- HDGC3500WR-S-2P - ***
1 2
- 1.Part No.
 - 2.Material:
(blank);Nylon 6T,UL94V-0
GWT:Nylon 6T,UL94V-0,GWT 750°C

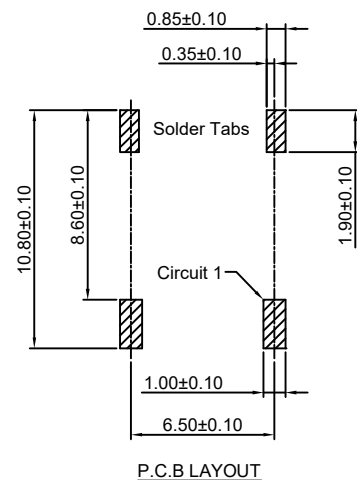
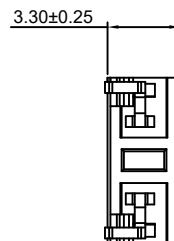
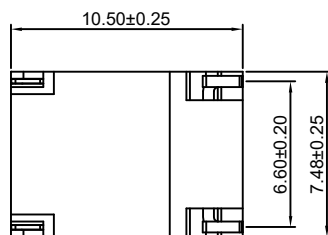
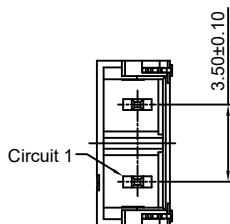
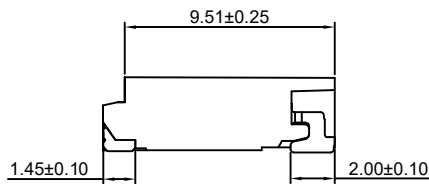
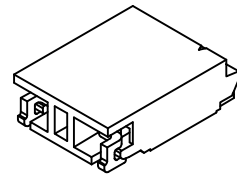

Unit: mm



HDGC3500 Series 3.50mm (.138") Pitch Wire to Board Connector

HDGC3500WRA-2P

3.50mm Pitch 90° Wafer

Reference Informations:

- *Material: Pin: Barss/Tin over Nickel
Insulator: Nylon 6T, UL94V-0
- *Mates with HDGC3500HA-2P series Housing
- *Color: White

Ordering Information:

HDGC3500WRA-2P - ***
1 2

1. Part No.
2. Material:
(blank): Nylon 6T, UL94V-0
GWT: Nylon 6T, UL94V-0, GWT 750°C

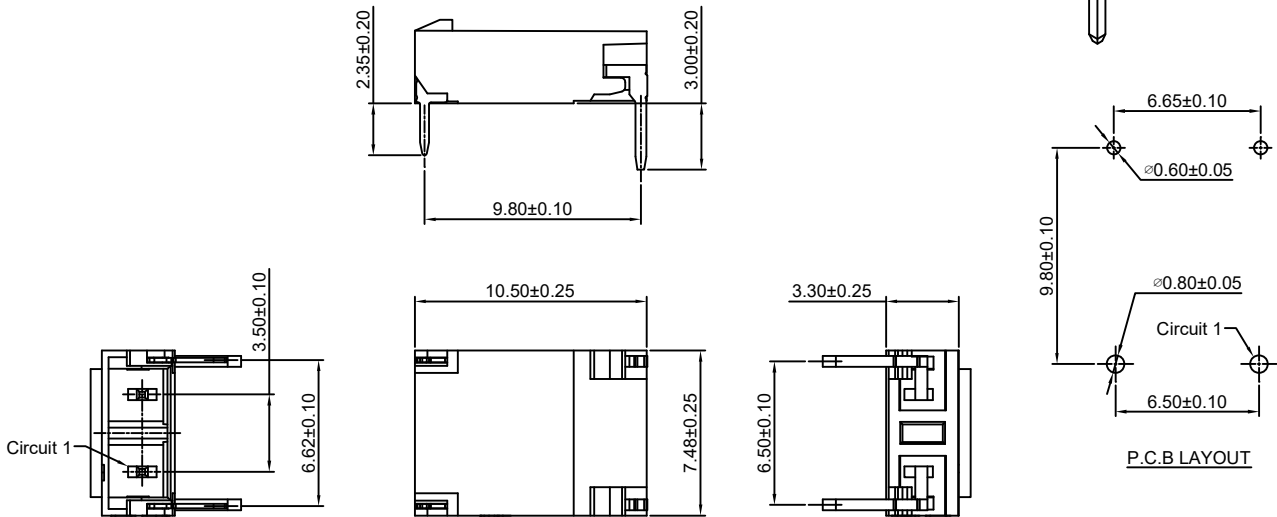
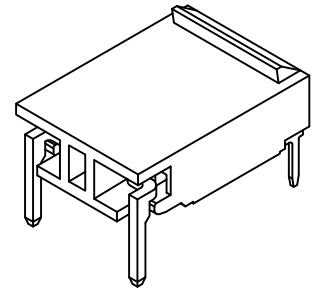

Unit: mm

HDGC3500WRA-S-2P

3.50mm Pitch 90° Wafer-SMY TYPE

Reference Informations:

- *Material: Pin: Barss/Tin over Nickel
Solder Tabs: Barss/Tin over Nickel
Insulator: Nylon 6T, UL94V-0
- *Mates with HDGC3500HA-2P series Housing
- *Color: White

Ordering Information:

HDGC3500WRA-S-2P - ***
1 2

1. Part No.
2. Material:
(blank): Nylon 6T, UL94V-0
GWT: Nylon 6T, UL94V-0, GWT 750°C

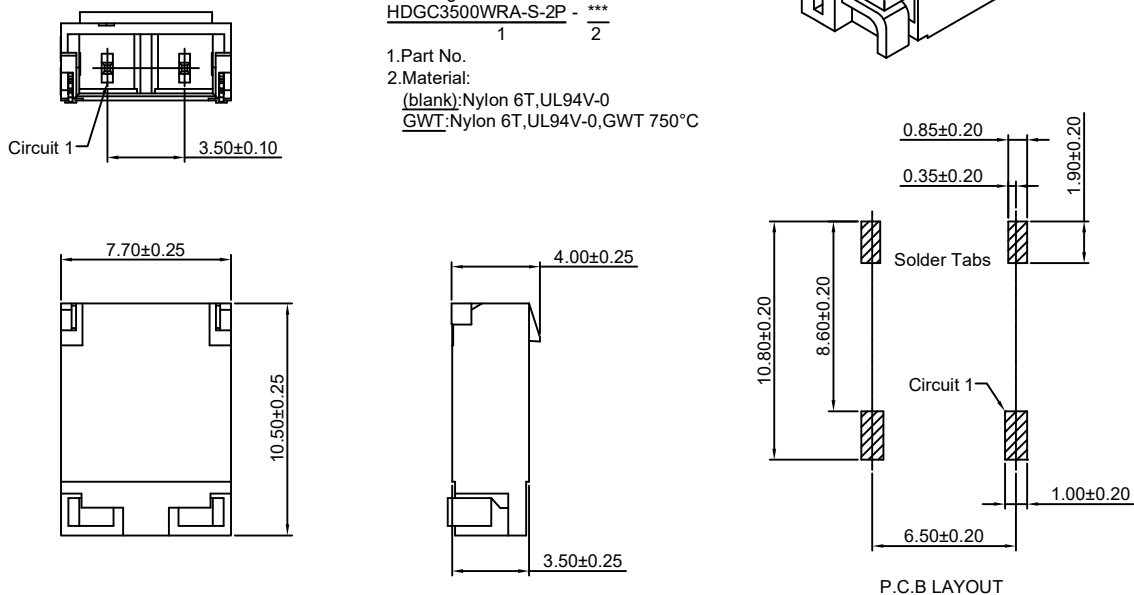
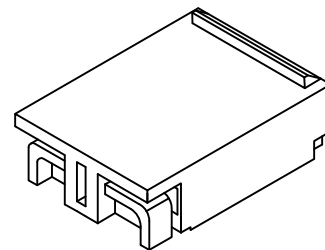

Unit: mm