

Specifications

- Current rating:3A AC,DC
- Voltage rating:250V AC,DC
- Temperature range:-25°C~+85°C
- Contact resistance:20mΩMax.
- Insulation resistance:1000MΩMin.
- Withstanding voltage:1500V AC/minute
- *Compliant with RoHS and REACH*
- *Meet the HF/Halogen Free,need to customize*
- *Contact HDGC for details*

Assembly layout

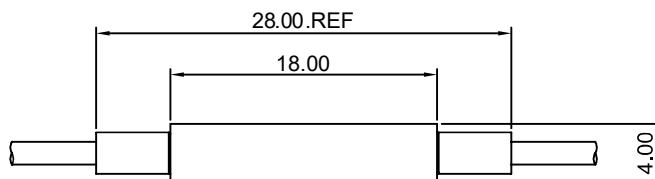

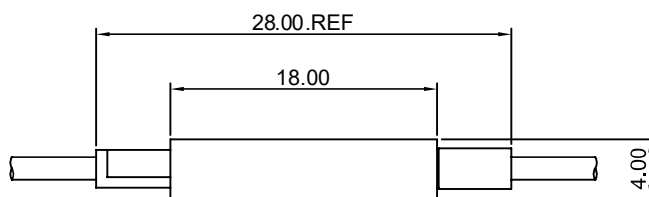

HDGC2548 Series 2.54mm (.100") Pitch Wire to Board Connector

HDGC2548HF-3P-P

2.54mm Pitch Housing

Reference Informations:

- *Material:Nylon 66,UL94V-0
- *Suitable HDGC2541-T series Terminal
- *Mates with HDGC2548HM-P-R series Housing
- *Color:Black

Ordering Information:

HDGC2548HF-3P-P - ***
1 2

- 1.Part No.
- 2.Material:
(blank):Nylon 66,UL94V-0
GWT:Nylon 66,UL94V-0,GWT 750°C

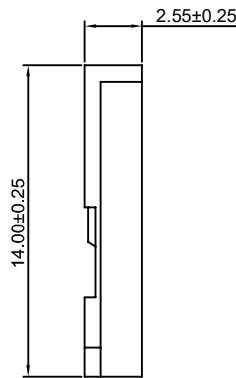
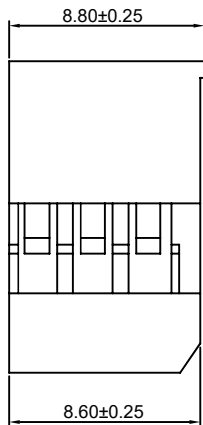
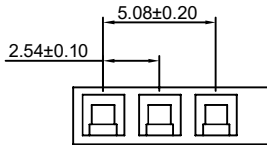
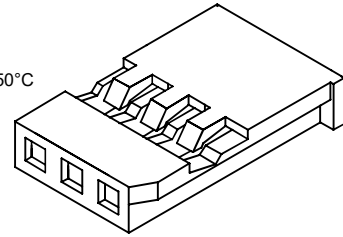

Unit: mm

HDGC2548HF-3P-R

2.54mm Pitch Housing

Reference Informations:

- *Material:Nylon 66,UL94V-0
- *Suitable HDGC2541-T series Terminal
- *Mates with HDGC2548HM-R-R series Housing
- *Color:Black

Ordering Information:

HDGC2548HF-3P-R - ***
1 2

- 1.Part No.
- 2.Material:
(blank):Nylon 66,UL94V-0
GWT:Nylon 66,UL94V-0,GWT 750°C

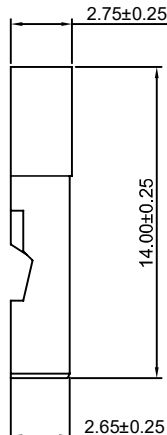
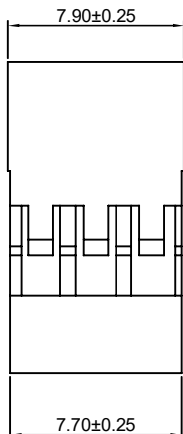
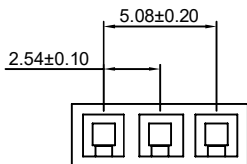
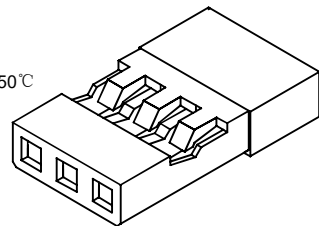

Unit: mm



HDGC2548 Series 2.54mm (.100") Pitch Wire to Board Connector

HDGC2548HMA-3P

2.54mm Pitch Housing

Reference Informations:

- *Material: PBT, UL94V-0
- *Suitable HDGC2541-T series Terminal
- *Mates with HDGC2548HF-3P-P series Housing
- *Color: Black

Ordering Information:

HDGC2548HMA-3P - *** - ***
 1 2 3

- 1. Part No.
- 2. Material:
 (blank): PBT30%GF, UL94V-0
 GWT: PBT, UL94V-0, GWT 750°C
- 3. Color:
 (blank): Black
 BRD: Brick red

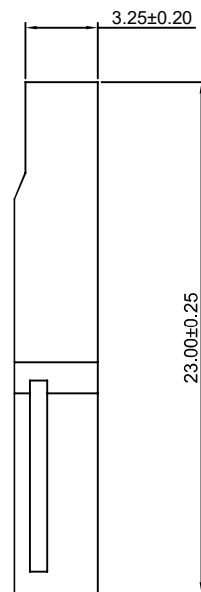
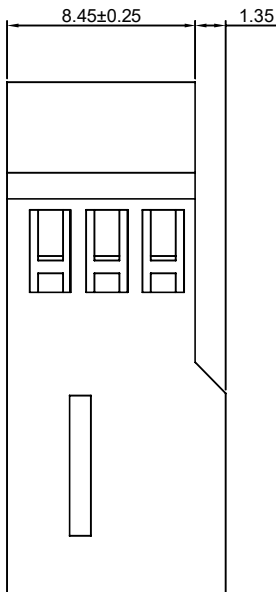
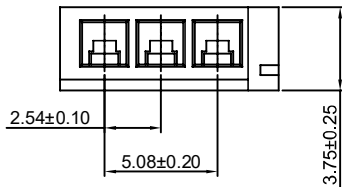
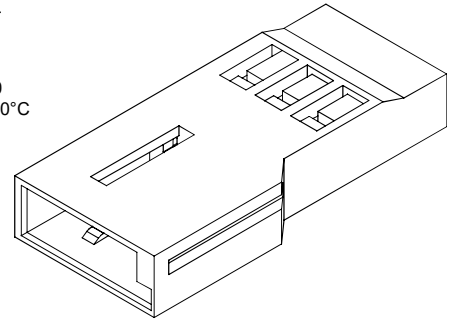

Unit: mm