

### Specifications

- Current rating:3A AC,DC
- Voltage rating:250V AC,DC
- Temperature range:-25°C~+85°C
- Contact resistance:10mΩMax.
- Insulation resistance:500MΩMin.
- Withstanding voltage:800V AC/minute
- \*Compliant with RoHS and REACH\*
- \*Meet the HF/Halogen Free,need to customize\*
- \*Contact HDGC for details\*

### Assembly layout

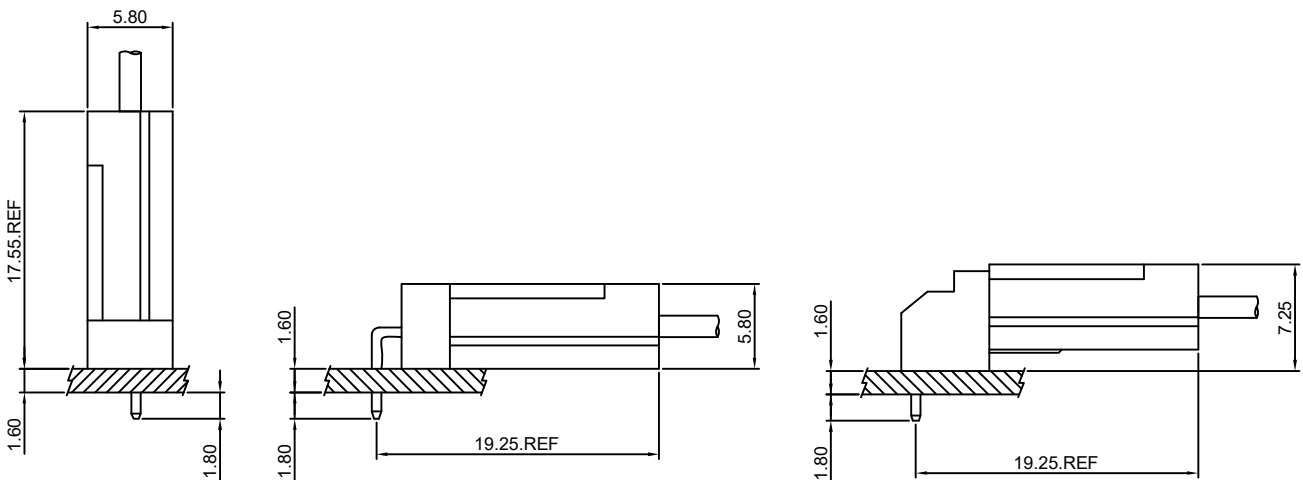



## HDGC2518 Series 2.50mm (.098") Pitch Wire to Board Connector

### HDGC2518-T

2.50mm Pitch Crimp Terminal

**Reference Informations:**

\*Used in HDGC2518H-XP series Housing

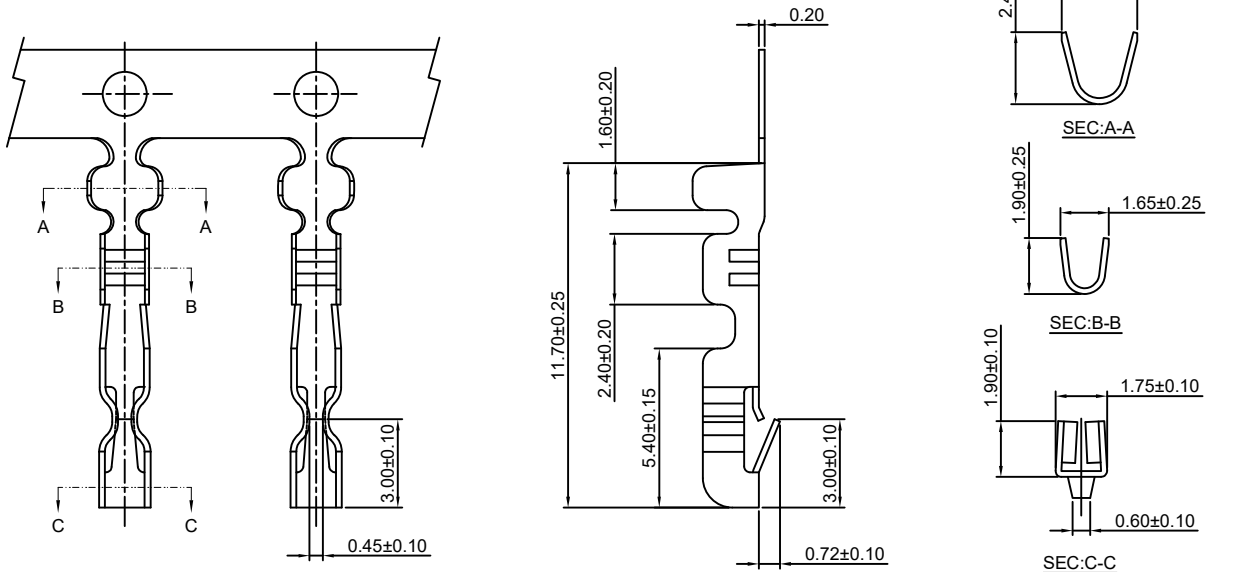

Ordering information & Specifications:

Part NO.	Wire Range	Insulation O.D.	Material	Finish	Qty/reel
HDGC2518-TB	AWG#20-#26	1.90mm(max)	Brass	Tin over Nickel	10,000 PCS
HDGC2518-TP	AWG#20-#26	1.90mm(max)	Phosphor Bronze	Tin over Nickel	10,000 PCS
HDGC2518-GB	AWG#20-#26	1.90mm(max)	Brass	Gold over Nickel	10,000 PCS
HDGC2518-GP	AWG#20-#26	1.90mm(max)	Phosphor Bronze	Gold over Nickel	10,000 PCS

Optional Gold plating available but MOQ requested

Unit:mm

### HDGC2518H-XP

2.50mm Pitch Housing

**Reference Informations:**

- \*Material:Nylon 66 , UL94V-0
- \*Suitable HDGC2518-T series Terminal
- \*Mates with HDGC2518WV,WR,WVR-XP series Wafer
- \*Color:White

**Ordering Information:**

- HDGC2518H-XP - \*\*\*
- |   |   |
|---|---|
| 1 | 2 |
|---|---|
- Part No.
  - Material:  
(Blank):Nylon 66,UL94V-0  
GWT:Nylon 66,UL94V-0,GWT 750 °C

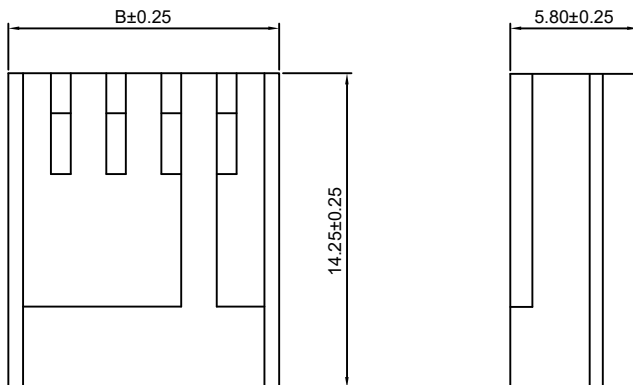
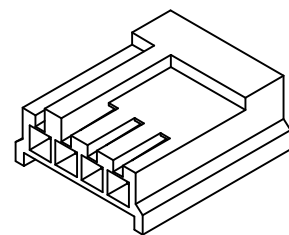
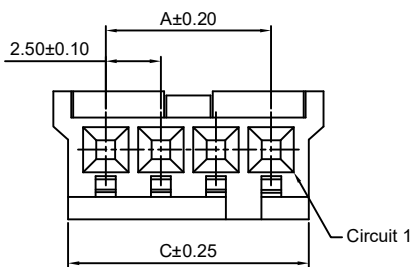

**Ordering Information & Dimensions:**

PART NO.	Dimensions		
	A	B	C
2P	2.50	7.25	5.90
3P	5.00	9.75	8.40
4P	7.50	12.25	10.90
5P	10.00	14.75	13.40
6P	12.50	17.25	15.90
7P	15.00	19.75	18.40
8P	17.50	22.25	20.90
9P	20.00	24.75	23.40
10P	22.50	27.25	25.90
11P	25.00	29.75	28.40
12P	27.50	32.25	30.90

Unit: mm



## HDGC2518 Series 2.50mm (.098") Pitch Wire to Board Connector

### HDGC2518WV-XP

2.50mm pitch 180° Wafer

**Reference Informations:**

- \*Material:Pin:Brass/Tin over Nickel  
Insulator:Nylon 66,UL94V-0
- \*Mates with HDGC2518H-XP series Housing
- \*Color:White

**Ordering Information:**

- HDGC2518WV-XP - \*\*\* - \*\*  
1 2 3
- Part No.
  - Material:  
(Blank):Nylon 66,UL94V-0  
GWT:Nylon 66,UL94V-0,GWT 750 °C
  - Finish:  
(blank):Tin over Nickel  
G:Gold over Nickel

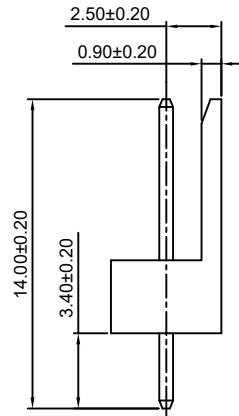
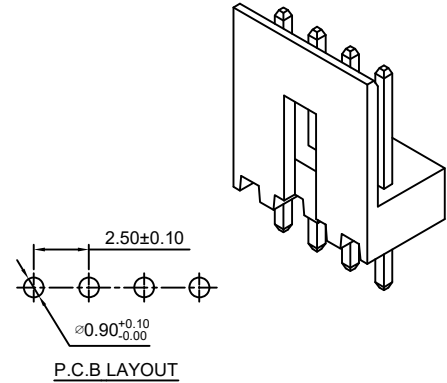
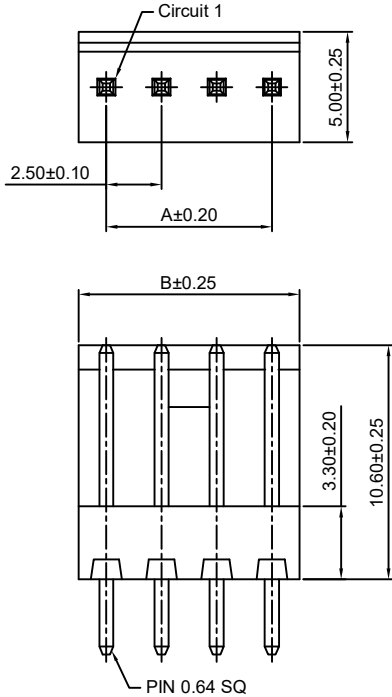

**Ordering Information & Dimensions:**

PART NO.	Dimensions	
	A	B
2P	2.50	5.00
3P	5.00	7.50
4P	7.50	10.00
5P	10.00	12.50
6P	12.50	15.00
7P	15.00	17.50
8P	17.50	20.00
9P	20.00	22.50
10P	22.50	25.00
11P	25.00	27.50
12P	27.50	30.00

Unit: mm

### HDGC2518WR-XP

2.50mm pitch 90° Wafer

**Reference Informations:**

- \*Material:Pin:Brass/Tin over Nickel  
Insulator:Nylon 66,UL94V-0
- \*Mates with HDGC2518H-XP series Housing
- \*Color:White

**Ordering Information:**

- HDGC2518WR-XP - \* - \*\*\* - \*\*  
1 2 3 4
- Part No.
  - Style:  
(blank):Type 1  
2:Type 2
  - Material:  
(Blank):Nylon 66,UL94V-0  
GWT:Nylon 66,UL94V-0,GWT 750 °C
  - Finish:  
(blank):Tin over Nickel  
G:Gold over Nickel

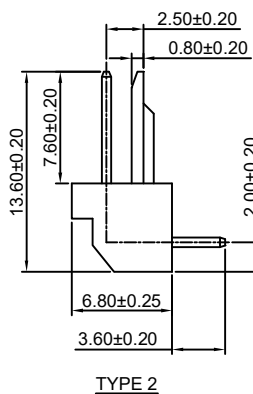
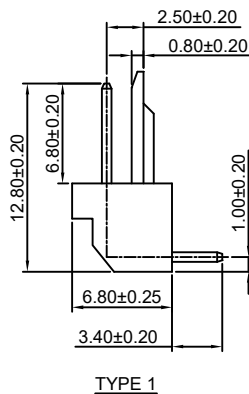
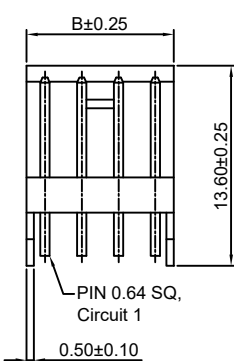
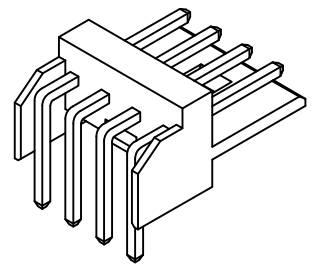
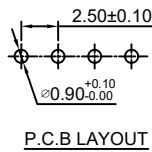
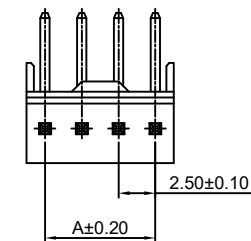

**Ordering Information & Dimensions:**

PART NO.	Dimensions	
	A	B
2P	2.50	5.00
3P	5.00	7.50
4P	7.50	10.00
5P	10.00	12.50
6P	12.50	15.00
7P	15.00	17.50
8P	17.50	20.00
9P	20.00	22.50
10P	22.50	25.00
11P	25.00	27.50
12P	27.50	30.00

Unit: mm



## HDGC2518 Series 2.50mm (.098") Pitch Wire to Board Connector

### HDGC2518WVR-XP

2.50mm pitch 90° Wafer

#### Reference Informations:

- \*Material:Pin:Brass/Tin over Nickel  
Insulator:Nylon 66,UL94V-0
- \*Mates with HDGC2518H-XP series Housing
- \*Color:White

#### Ordering Information:

HDGC2518WVR-XP - \*\*\* - \*\*  
1 2 3

- 1.Part No.
- 2.Material:  
(Blank):Nylon 66,UL94V-0  
GWT:Nylon 66,UL94V-0,GWT 750 °C
- 3.Finish:  
(blank):Tin over Nickel  
G:Gold over Nickel

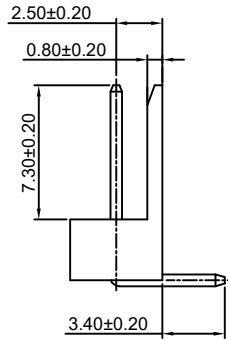
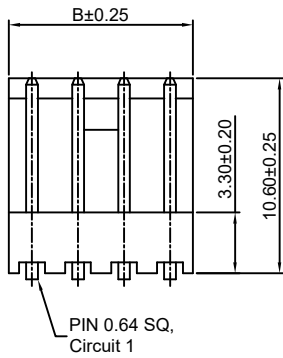
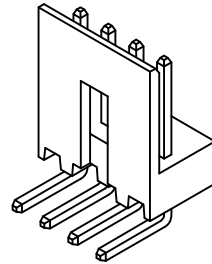
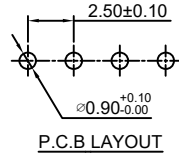
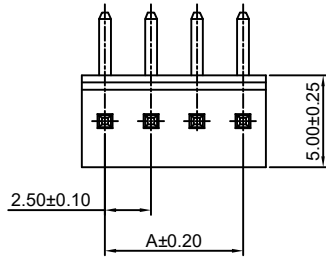

#### Ordering Information & Dimensions:

PART NO.	Dimensions	
	A	B
2P	2.50	5.00
3P	5.00	7.50
4P	7.50	10.00
5P	10.00	12.50
6P	12.50	15.00
7P	15.00	17.50
8P	17.50	20.00
9P	20.00	22.50
10P	22.50	25.00
11P	25.00	27.50
12P	27.50	30.00

Unit: mm