

Specifications

- Current rating: 1A AC,DC
- Voltage rating: 200V AC,DC
- Temperature range: -25°C~+85°C
- Contact resistance: 20mΩMax.
- Insulation resistance: 500MΩMin.
- Withstanding voltage: 500V AC/minute
- *Compliant with RoHS and REACH*
- *Meet the HF/Halogen Free, need to customize*
- *Contact HDGC for details*

Assembly layout

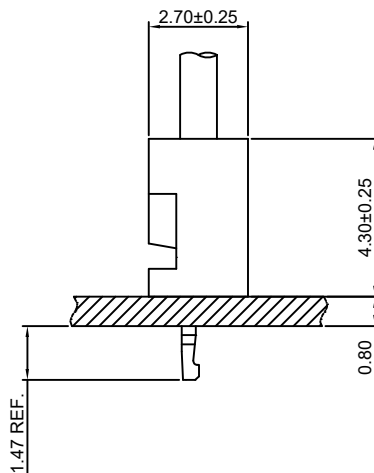



HDGC1504 Series 1.50mm (.059") Pitch Board to Board Connector

HDGC1504-T

1.50mm pitch Crimp Terminal

Reference Informations:

*Used in HDGC1504H-XP series Housing

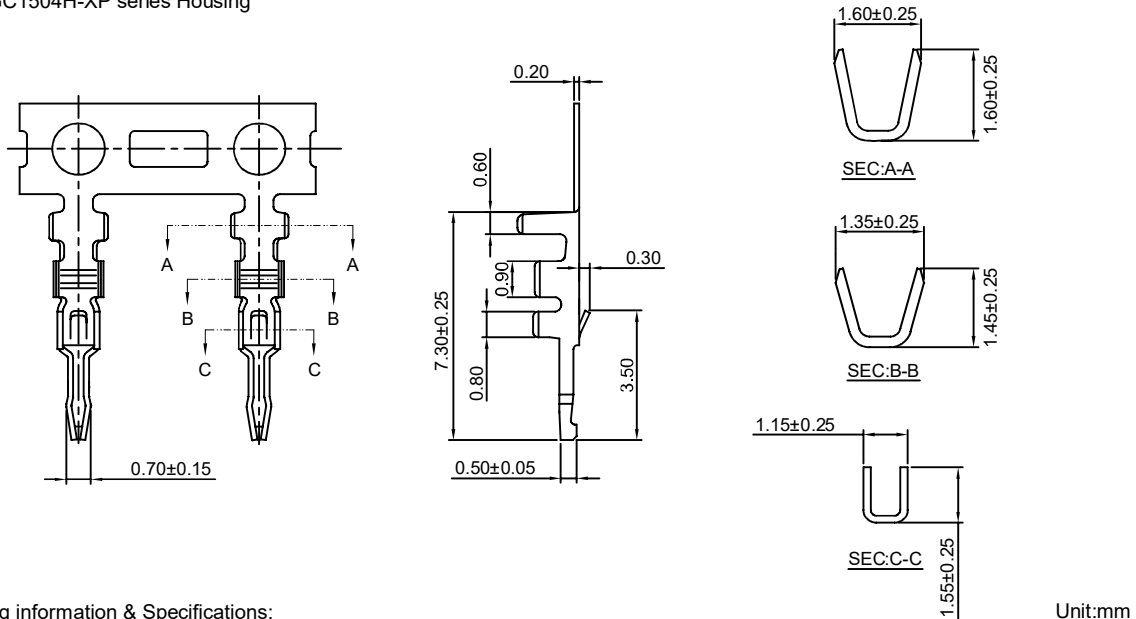

Ordering information & Specifications:

Part NO.	Wire Range	Insulation O.D.	Material	Finish	Qty/reel
HDGC1504-TB	AWG#28-#30	1.00mm(max)	Brass	Tin over Nickel	10,000 PCS
HDGC1504-TP	AWG#28-#30	1.00mm(max)	Phosphor Bronze	Tin over Nickel	10,000 PCS
HDGC1504-GB	AWG#28-#30	1.00mm(max)	Brass	Gold over Nickel	10,000 PCS
HDGC1504-GP	AWG#28-#30	1.00mm(max)	Phosphor Bronze	Gold over Nickel	10,000 PCS

Optional Gold plating available but MOQ requested

Unit:mm

HDGC1504H-XP

1.50mm pitch Housing

Reference Informations:

*Material:Nylon 66,UL94V-0

*Suitable HDGC1504-T series Terminal

*Color:White

Ordering Information:

HDGC1504H-XP - ***

1 2

1.Part No.

2.Material:

(blank):Nylon 66,UL94V-0

GWT:Nylon 66,UL94V-0,GWT 750°C

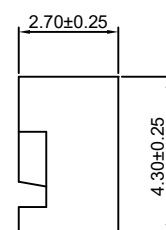
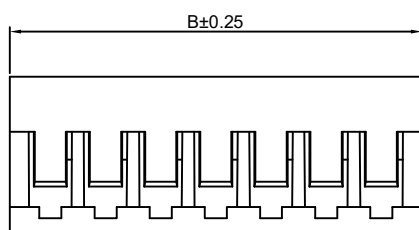
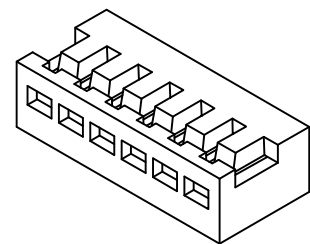
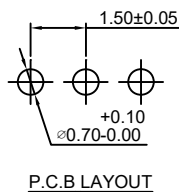
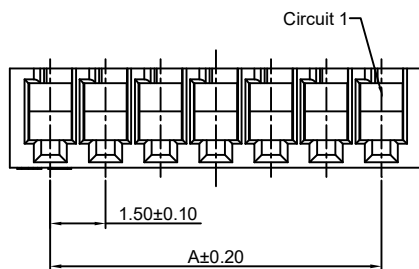

Ordering Information & Dimensions:

PART NO.	Dimensions	
	A	B
2P	1.50	3.70
3P	3.00	5.20
4P	4.50	6.70
5P	6.00	8.20
6P	7.50	9.70
7P	9.00	11.20
8P	10.50	12.70
9P	12.00	14.20
10P	13.50	15.70
11P	15.00	17.20
12P	16.50	18.70
13P	18.00	20.20
14P	19.50	21.70
15P	21.00	23.20

Unit: mm