

Specifications

- Current rating: 1.2A AC,DC
- Voltage rating: 250V AC,DC
- Temperature range: -25°C~+85°C
- Contact resistance: 20mΩMax.
- Insulation resistance: 1000MΩMin.
- Withstanding voltage: 500V AC/minute
- *Compliant with RoHS and REACH*
- *Meet the HF/Halogen Free, need to customize*
- *Contact HDGC for details*



HDGC1272 Series 1.27mm (.050") Pitch IDC Wire to Board Connector

HDGC1272H-XP

1.27mm Flat IDC Connector

Reference Informations:

*Material:

Terminal: Phosphor bronze/Tin over Nickel
Housing: PBT, UL94V-0

*Mates with HDGC1272WV, WV-F, WV-S-F-XP series Wafer

*Color: White

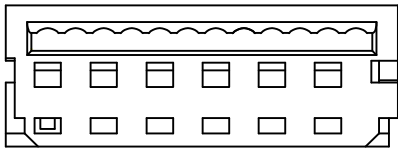

Ordering Information:

HDGC1272H-XP - *
1 2

1. Part No.

2. Material:

(Blank): Tin over Nickel

G: Gold over Nickel

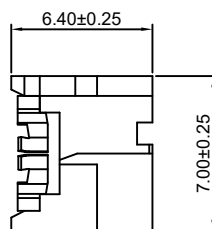
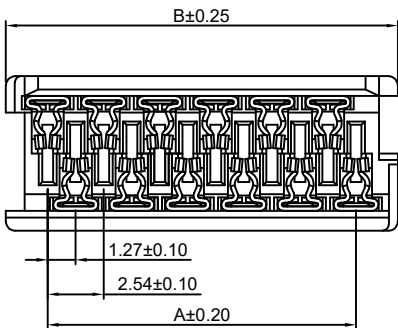
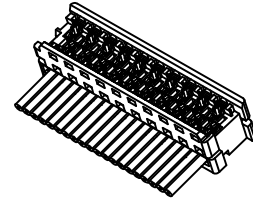

Ordering Information & Dimensions:

PART NO.	Dimensions	
	A	B
4P	3.81	7.59
6P	6.35	10.13
8P	8.89	12.67
10P	11.43	15.21
12P	13.97	17.75
14P	16.51	20.29
16P	19.05	22.83
18P	21.59	25.37
20P	24.13	27.91
22P	26.67	30.45
24P	29.21	32.99
26P	31.75	35.53

Unit: mm

HDGC1272WV-XP

1.27mm IDC 180° Wafer

Reference Informations:

*Material:

Terminal: Phosphor bronze/Tin over Nickel
Housing: Nylon 66, UL94V-0

*Mates with HDGC1272H-XP series Housing

*Color: Black

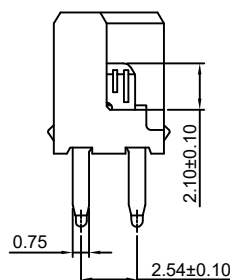
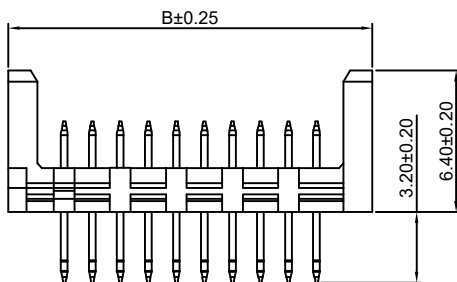
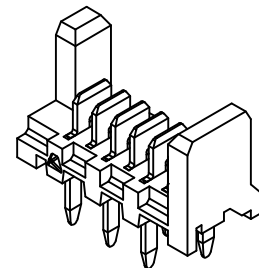
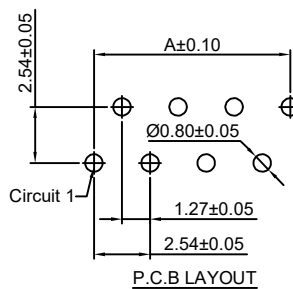
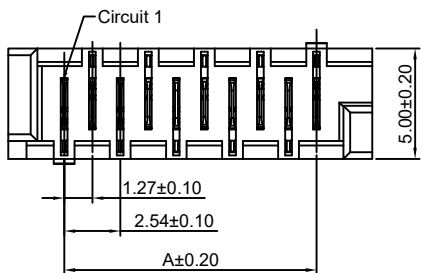

Ordering Information & Dimensions:

PART NO.	Dimensions	
	A	B
4P	3.81	8.86
6P	6.35	11.40
8P	8.89	13.94
10P	11.43	16.48
12P	13.97	19.02
14P	16.51	21.56
16P	19.05	24.10
18P	21.59	26.64
20P	24.13	29.18
22P	26.67	31.72
24P	29.21	34.26
26P	31.75	36.80

Unit: mm



HDGC1272 Series 1.27mm (.050") Pitch IDC Wire to Board Connector

HDGC1272WV-F-XP

1.27mm IDC 180° Wafer

Reference Informations:

*Material:

Terminal: Phosphor bronze/Tin over Nickel
Housing: Nylon 66, UL94V-0

*Mates with HDGC1272H-XP series Housing

*Color: Black

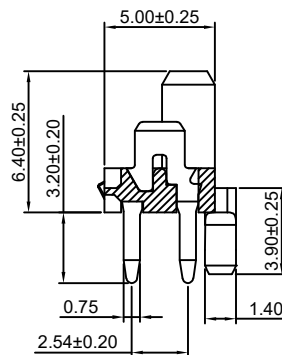
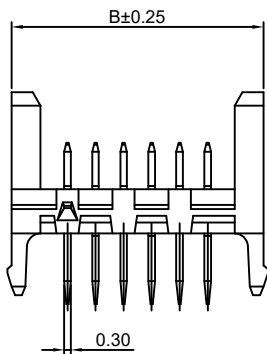
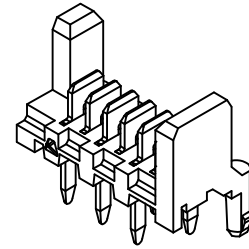
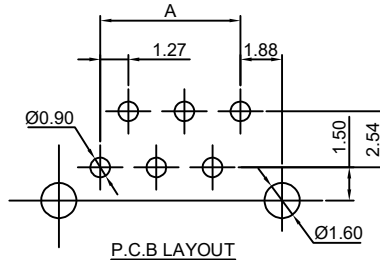
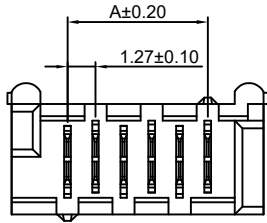

Ordering Information & Dimensions:

PART NO.	Dimensions	
	A	B
4P	3.81	8.86
6P	6.35	11.40
8P	8.89	13.94
10P	11.43	16.48
12P	13.97	19.02
14P	16.51	21.56
16P	19.05	24.10
18P	21.59	26.64
20P	24.13	29.18
22P	26.67	31.72
24P	29.21	34.26
26P	31.75	36.80

Unit: mm

HDGC1272WV-S-F-XP

1.27mm IDC 180° Wafer - SMT TYPE

Reference Informations:

*Material:

Terminal: Phosphor bronze/Tin over Nickel
Housing: LCP, UL94V-0

*Mates with HDGC1272H-XP series Housing

*Color: Black

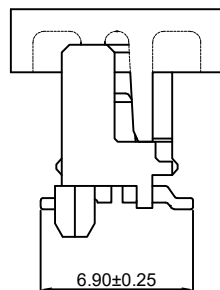
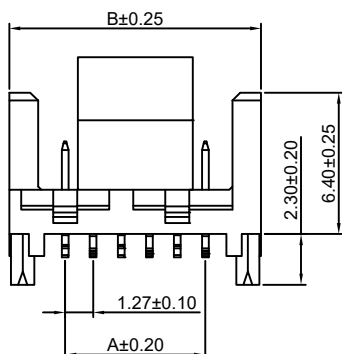
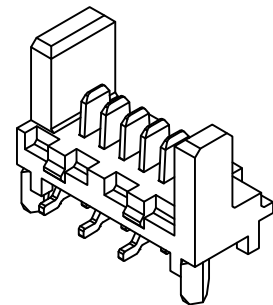
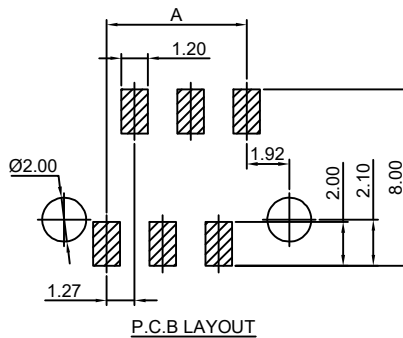
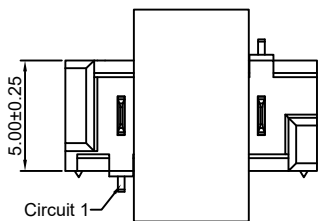

Ordering Information & Dimensions:

PART NO.	Dimensions	
	A	B
4P	3.81	8.86
6P	6.35	11.40
8P	8.89	13.94
10P	11.43	16.48
12P	13.97	19.02
14P	16.51	21.56
16P	19.05	24.10
18P	21.59	26.64
20P	24.13	29.18
22P	26.67	31.72
24P	29.21	34.26
26P	31.75	36.80

Unit: mm



HDGC1272 Series 1.27mm (.050") Pitch IDC Wire to Board Connector

HDGC1272HV-XP

1.27mm Flat IDC Connector

Reference Informations:

*Material:

Terminal: Phosphor bronze/Tin over Nickel

Housing: PBT, UL94V-0

*Color: White

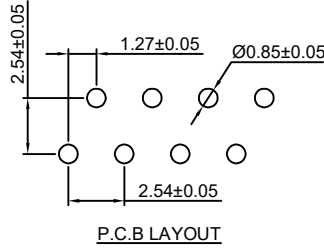
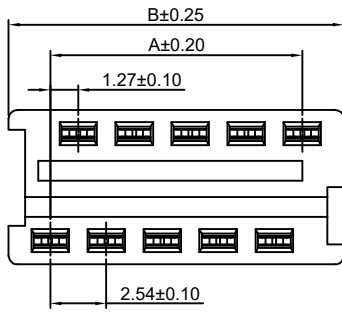
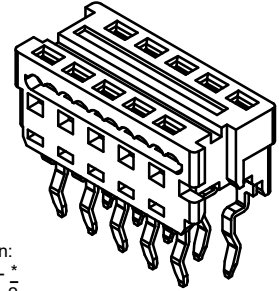

Ordering Information:
HDGC1272HV-XP - *
1 2

1.Part No.

2.Material:

(Blank): Tin over Nickel

G: Gold over Nickel

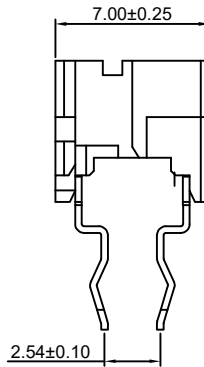
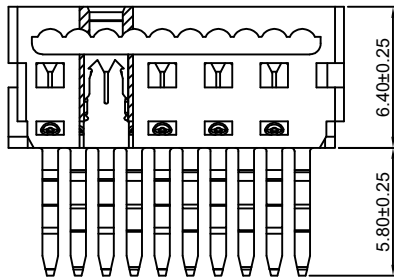

Ordering Information & Dimensions:

PART NO.	Dimensions	
	A	B
4P	3.81	8.86
6P	6.35	11.40
8P	8.89	13.94
10P	11.43	16.48
12P	13.97	19.02
14P	16.51	21.56
16P	19.05	24.10
18P	21.59	26.64
20P	24.13	29.18
22P	26.67	31.72
24P	29.21	34.26
26P	31.75	36.80

Unit: mm