

修订 REV	标记 MARK	修改摘要 REVISION DESCRIPTION	签名 SIGNATURE	日期 DATE
AO		NEW RELEASE	WANG	2012-05-10

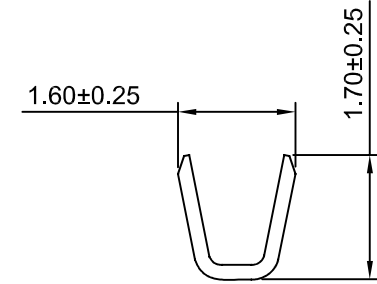

SEC:A-A

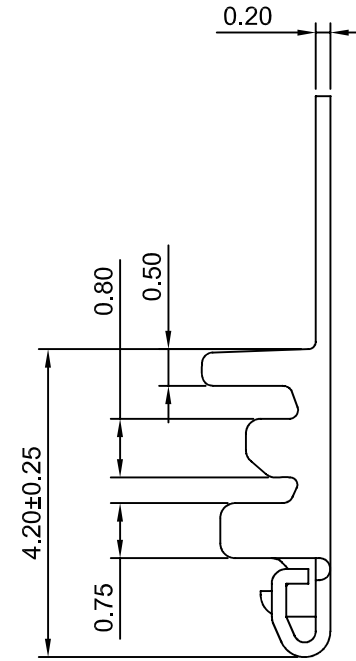
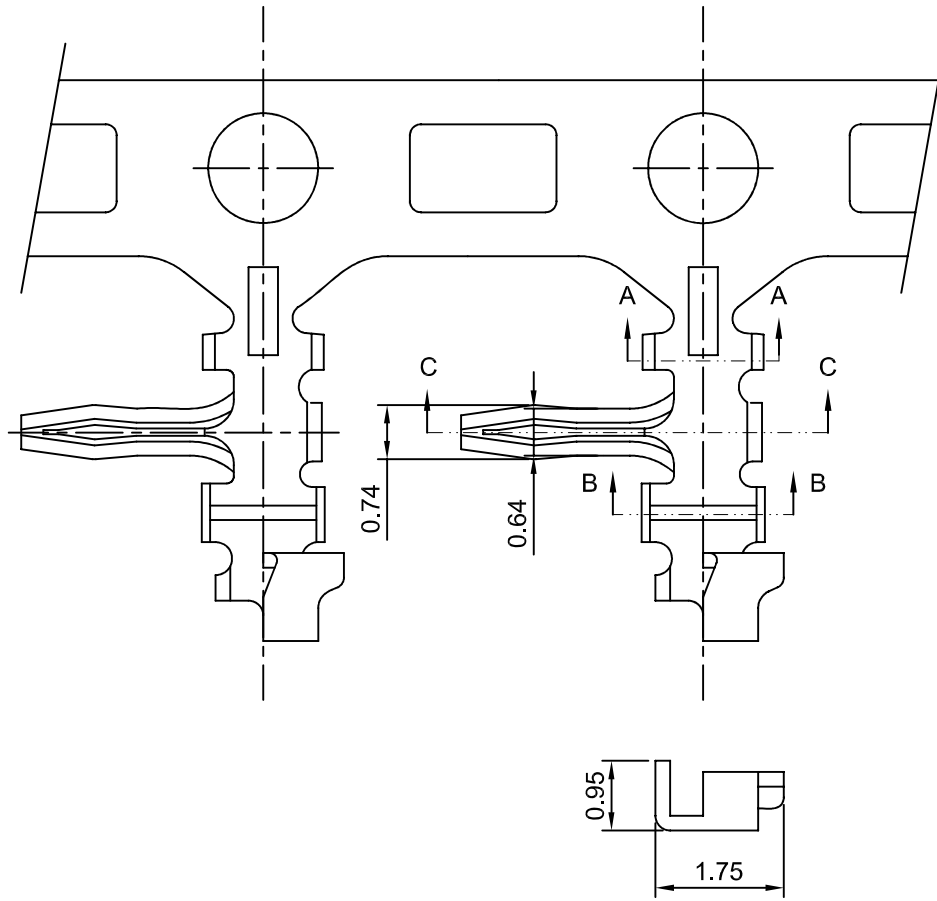
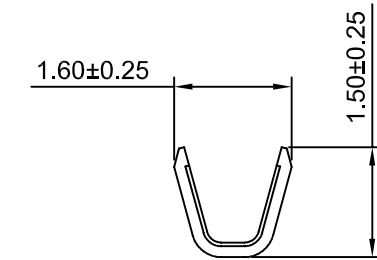

SEC:B-B

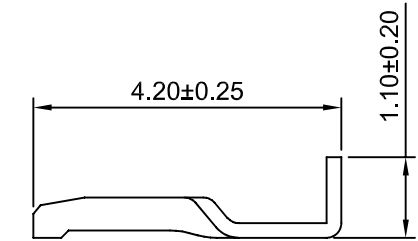

SEC:C-C

Ordering information & Specifications

Unit:mm

Part No	Wire Range	Insulation O.D.	Material	Finish	Qty/reel
HDGC1503-TB	AWG#28-#30	1.00mm(max)	Brass	Tin over Nickel	15,000 PCS
HDGC1503-TP	AWG#28-#30	1.00mm(max)	Phosphor Bronze	Tin over Nickel	15,000 PCS
HDGC1503-GB	AWG#28-#30	1.00mm(max)	Brass	Gold over Nickel	15,000 PCS
HDGC1503-GP	AWG#28-#30	1.00mm(max)	Phosphor Bronze	Gold over Nickel	15,000 PCS

Optional Gold plating available but MOQ requested



深圳市华德共创科技有限公司

Shenzhen Huade co-create Technology Co.,LTD

TEL : 0755-27129737 FAX : 0755-29940187

-TOLERANCES- UNLESS OTHERWISE SPECIFIED 公差参数表						TITLE: 1.50mm Pitch 产品名称: Crimp Terminal			
X.X	±0.30	X.X°	±3°	APPD: 核准:	XIE	PART NO: 产品编号: HDGC1503-T			
X.XX	±0.30	X.XX°	±2°	CHECK: 校对:	WANG	DATE	SCALE	UNIT	CODE NUMBER
X.XXX	±0.10	X.XXX°	±1°	DRAW: 绘图:	WANG	2012-05-10	10:1	mm	A008

修订 REV	标记 MARK	修改摘要 REVISION DESCRIPTION	签名 SIGNATURE	日期 DATE
AO		NEW RELEASE	WANG	2012-05-10

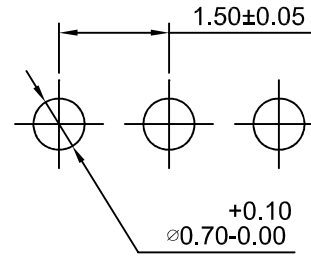
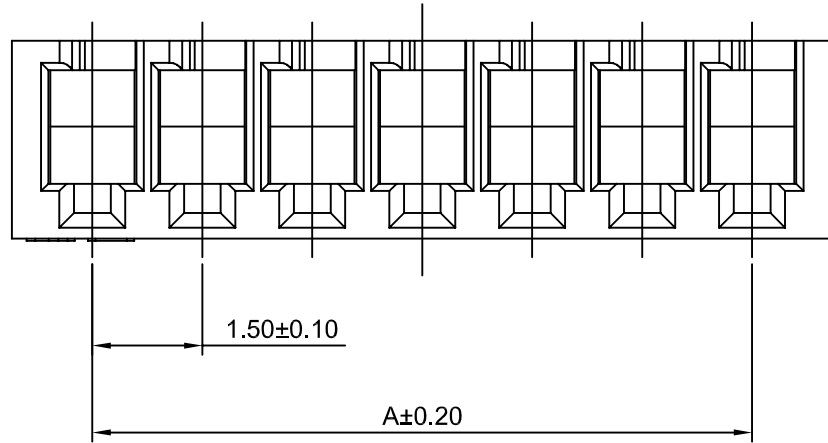

P.C.B LAYOUT

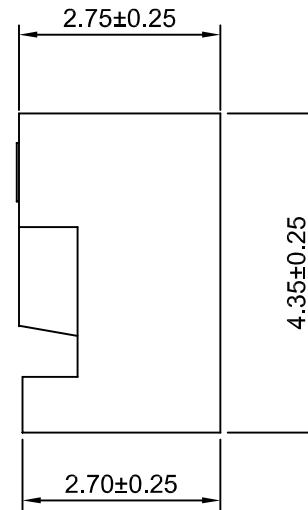
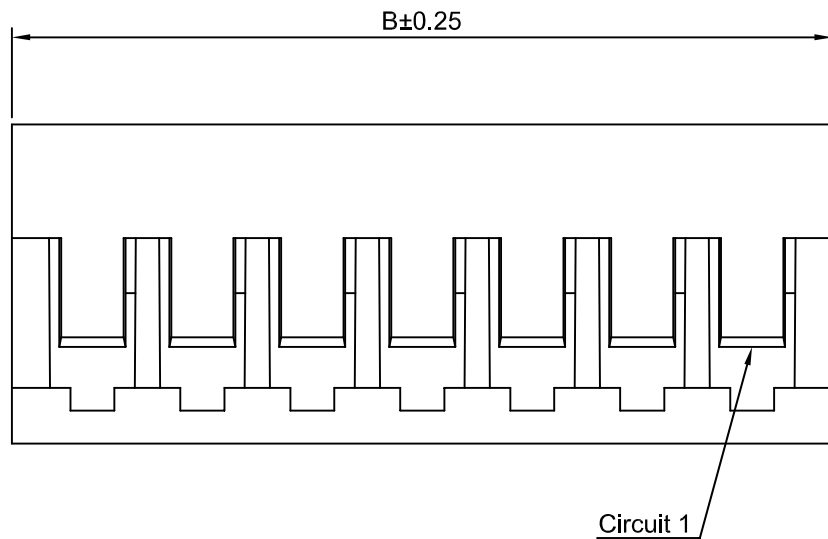
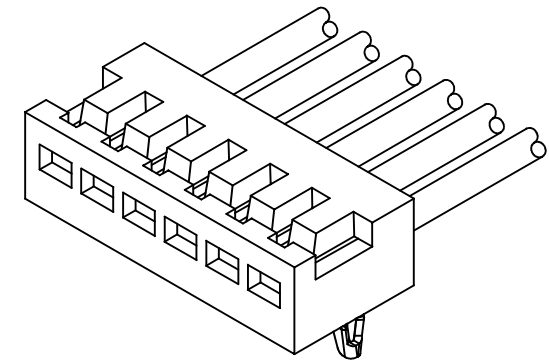

Ordering Information & Dimensions

Circuits	Dimensions(mm)		Circuits	Dimensions(mm)	
	A	B		A	B
2P	1.50	3.70	9P	12.00	14.20
3P	3.00	5.20	10P	13.50	15.70
4P	4.50	6.70	11P	15.00	17.20
5P	6.00	8.20	12P	16.50	18.70
6P	7.50	9.70	13P	18.00	20.20
7P	9.00	11.20	14P	19.50	21.70
8P	10.50	12.70	15P	21.00	23.20

SPECIFICATIONS:

Current Rating: 1A AC,DC
Voltage Rating: 200V AC,DC
Temperature Range: -25°C ~ +85°C
Contact Resistance: 20mΩ Max
Insulation Resistance: 500MΩ Min
Withstanding Voltage: 500V AC/minute
Material: Nylon66,UL94V-0(White)



深圳市华德共创科技有限公司

Shenzhen Huade co-create Technology Co.,LTD

TEL : 0755-27129737 FAX : 0755-29940187

-TOLERANCES- UNLESS OTHERWISE SPECIFIED 公差参数表				TITLE: 产品名称: 1.50mm Pitch Housing	
X.X	±0.30	X.X°	±3°	APPD: 核准:	XIE
X.XX	±0.30	X.XX°	±2°	CHECK: 校对:	WANG
X.XXX	±0.10	X.XXX°	±1°	DRAW: 绘图:	WANG
PART NO: 产品编号:		HDGC1503H-XP			
DATE	SCALE	UNIT	CODE NUMBER		
2012-05-10	10:1	mm	A008		